

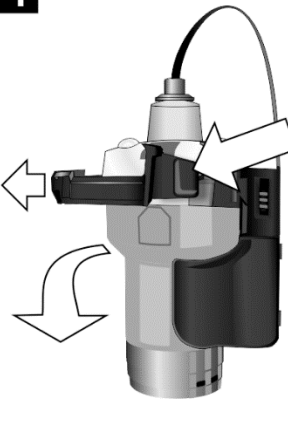

SafePro AIS  
SafePro  
Safe  
EPIRB-AIS  
USER MANUAL

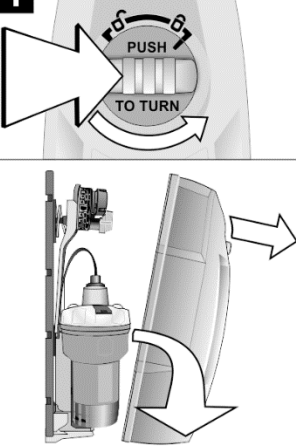
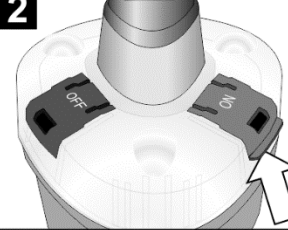
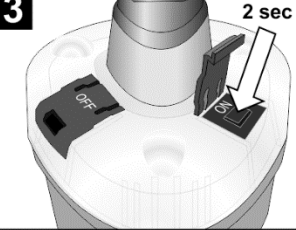
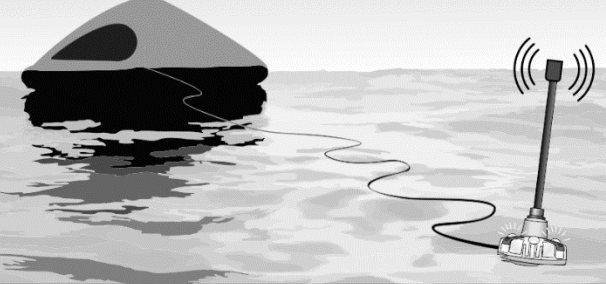

This manual is applicable to the SafePro AIS, SafePro and Safe EPIRBs. The SafePro AIS and SafePro models contain a GNSS receiver for improved positional accuracy. Some parts of this manual are applicable only to the SafePro AIS and SafePro models and are marked accordingly.

<p><b>ONLY IN EMERGENCY</b> FALSE ALERTS ENDANGER LIVES.</p>	<h1>SOS ONLY IN EMERGENCY</h1>	
<p><b>1. Remove the EPIRB completely from its bracket (left) or enclosure (right).</b></p> <p>The enclosure is spring loaded to automatically release the EPIRB if your vessel sinks.</p>	<p><b>1</b></p> 	<p><b>1</b></p> 
<p><b>2. If time permits, lift the red "ON" cover, then press the activation button for 2 seconds.</b></p>	<p><b>2</b></p> 	<p><b>3</b></p> 
<p><b>3. Uncoil the EPIRB's lanyard and tie it to the life raft. Throw the EPIRB into the water (it will self-activate if you did not have time to press the activation button).</b></p>		

# CONTENTS

<b>1</b>	<b>SAFETY NOTICES .....</b>	<b>1</b>
1.1	Use .....	1
1.2	Testing, maintenance and disposal.....	1
1.3	Hazards .....	1
1.4	EU Declaration of Conformity.....	1
1.5	FCC Compliance .....	1
1.6	Industry Canada Compliance.....	1
1.7	Response time .....	2
1.8	Disclaimer.....	2
<b>2</b>	<b>MANDATORY REGISTRATION .....</b>	<b>3</b>
2.1	Overview .....	3
2.2	How to register .....	3
<b>3</b>	<b>DESCRIPTION .....</b>	<b>4</b>
3.1	EPIRB controls and indicators .....	5
3.1.1	Top view .....	5
3.1.2	Back view .....	6
3.2	Carry handle.....	7
3.3	Manual bracket.....	8
3.4	Float-free enclosure .....	9
3.4.1	Automatic activation .....	9
3.4.2	Manual activation.....	9
<b>4</b>	<b>EMERGENCY PROCEDURE.....</b>	<b>10</b>
4.1	Abandon ship! .....	10
4.1.1	Float-free enclosure .....	11
4.2	Release from manual bracket .....	11
4.3	Release from float-free enclosure .....	12
4.4	Manual activation .....	13
4.5	Optimising onboard performance.....	14
4.6	Deactivation.....	15
4.7	Stowage .....	16
4.7.1	Manual bracket.....	16
4.7.2	Float-free enclosure .....	17
<b>5</b>	<b>FALSE ALERTS .....</b>	<b>19</b>
5.1	Notify rescue services .....	19
5.2	Deactivate the EPIRB.....	19
5.3	Faulty EPIRB.....	19
<b>6</b>	<b>INSTALLATION .....</b>	<b>20</b>
6.1	Manual bracket.....	20

6.1.1	Siting .....	20
6.1.2	Mounting procedure .....	20
6.1.3	Mounting instruction plate .....	21
6.2	Float-free enclosure .....	22
6.2.1	Siting .....	22
6.2.2	Mounting procedure .....	23
6.2.3	Mounting instruction plate .....	24
6.2.4	HRU expiry date.....	24
6.2.5	Marking vessel name .....	24
<b>7</b>	<b>MAINTENANCE .....</b>	<b>25</b>
7.1	Servicing schedule.....	25
7.2	Self-test & inspection .....	26
7.2.1	Short self-test.....	26
7.2.2	Long self-test (GNSS variants only) .....	27
7.3	Mechanical inspection .....	28
7.4	HRU replacement .....	29
7.5	Battery maintenance.....	32
7.5.1	Battery replacement.....	32
7.5.2	Battery removal.....	32
7.6	Transportation.....	34
7.7	GMDSS inspections.....	34
<b>8</b>	<b>END OF LIFE STATEMENT.....</b>	<b>35</b>
8.1	Disposal .....	35
<b>9</b>	<b>TECHNICAL SPECIFICATION.....</b>	<b>36</b>
<b>10</b>	<b>PRODUCT WARRANTY .....</b>	<b>37</b>
10.1	Orolia Warranty Registration .....	37
10.2	Warranty Statement.....	37
<b>11</b>	<b>HOW DOES IT WORK? .....</b>	<b>39</b>
<b>12</b>	<b>COSPAS-SARSAT SATELLITE SYSTEM.....</b>	<b>40</b>
12.1	The Search And Rescue (SAR) process .....	40
12.2	Global Navigation Satellite System (GNSS).....	41
12.3	MEOSAR Compatibility Explained.....	41
<b>13</b>	<b>HOW TO REGISTER YOUR EPIRB.....</b>	<b>43</b>
13.1	Emergency contact .....	43
13.2	Registration Information for Australia & New Zealand .....	44
13.2.1	Advice for EPIRB purchase or transfer.....	44
13.3	Online warranty registration.....	45
13.4	Radio licence .....	45
13.5	Sale or transfer .....	45

# 1 SAFETY NOTICES

## 1.1 Use

An EPIRB (Emergency Position Indicating Radio Beacon) is for use in maritime emergencies and is approved for these contingencies. It is not designed or recommended for use on land or in the air.

Use the EPIRB only in situations of grave and imminent danger. False alerts endanger lives. Help to prevent them; understand how to activate and deactivate your equipment. Intentional false alerts may involve penalties.

Read the complete manual before installing, testing or using the EPIRB.

Ensure the EPIRB is registered with your local authorities (Flag State nation) – see page 3.

## 1.2 Testing, maintenance and disposal

Ensure you test the EPIRB monthly – see page 26.

The EPIRB contains no user serviceable parts. The battery pack contains lithium metal batteries. Do not incinerate, puncture, deform or short-circuit. If you need to dispose of batteries or the complete EPIRB – see page 35. Return to your dealer for service – see page 25.

## 1.3 Hazards

This EPIRB emits radio frequency radiation when activated. It is advisable not to handle the antenna while the EPIRB is activated.

It is not advisable to stare directly at the strobe lights.

## 1.4 EU Declaration of Conformity

Hereby Orolia® declares that this EPIRB is in compliance with the essential requirements and other relevant provisions of the current EU Marine Equipment Directive (MED). A copy of the Declaration of Conformity can be obtained online from: <https://www.oroliamaritime.com/support/>

## 1.5 FCC Compliance

This device complies with the GMDSS provisions of Part 80 of the FCC rules.

## 1.6 Industry Canada Compliance

This device contains licence-exempt transmitter(s)/receiver(s) that comply with Innovation, Science and Economic Development Canada's licence-exempt RSS(s). Operation is subject to the following two conditions:

1. This device may not cause interference.
2. This device must accept any interference, including interference that may cause undesired operation of the device.

## **1.7 Response time**

The function of the EPIRB is to send an alert to COSPAS-SARSAT satellites as described on page 40. How soon an alert is received depends on the positions of the satellites at the time and can be influenced by overhead obstructions aboard the vessel. Rescue time following an alert depends on the overall performance of the Search and Rescue organisations which is outside the control of Orolia.

## **1.8 Disclaimer and copyright**

Orolia reserves the right to change this specification at any time without notice and hereby specifically disclaims liability for any consequences of such action.

THIS DOCUMENT IS COPYRIGHT © 2019 OROLIA GROUP AND/OR ITS AFFILIATES. ALL RIGHTS ARE STRICTLY RESERVED.

THIS DOCUMENT AND ANY ATTACHED MATERIALS CONTAINS PROPRIETARY INFORMATION AND DATA AND IS THE SOLE PROPERTY OF OROLIA GROUP AND/OR ITS AFFILIATES. THE DOCUMENTS, ANY ATTACHED MATERIALS AND/OR INFORMATION CONTAINED THEREIN MUST NOT BE USED, DISSEMINATED, OR DISTRIBUTED EXCEPT FOR THE AGREED PURPOSE. UNAUTHORIZED USE, REPRODUCTION, OR ISSUE TO ANY THIRD PARTY IS NOT PERMITTED WITHOUT THE PRIOR WRITTEN CONSENT OF THE OROLIA GROUP. THIS DOCUMENT IS TO BE RETURNED TO THE OROLIA GROUP WHEN THE AGREED PURPOSE IS FULFILLED.

## 2 MANDATORY REGISTRATION

### **WARNING!**

**You must register your EPIRB with the appropriate authorities.  
Failure to register may slow the rescue and lead to loss of life.  
In the USA failure to register may result in a fine.  
In the UK you are legally required to register your EPIRB.**

### 2.1 Overview

Every EPIRB is pre-programmed with a unique identity before it reaches the customer. This is performed by the manufacturer or, in some cases, the distributor. The identity includes a 3 digit country code. This is the country that takes responsibility for storing that particular EPIRB's registration details. In most cases, this is the country to which the vessel is flagged. The country programmed into your EPIRB can be found from its rear identity label. You **must** register with this country.

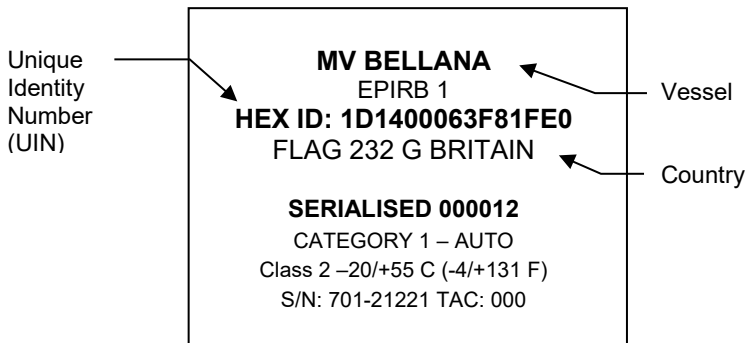

When you activate your EPIRB in an emergency, the nearest maritime search and rescue coordination centre (MRCC) will receive the message and decode the country code. They will then access the registration database for that country and expect to find details of your vessel, its radio equipment and who to contact. If they fail to find this information, this may slow down any rescue.

### 2.2 How to register

Please refer to page 43 for detailed information about the registration process.



### 3 DESCRIPTION

This EPIRB is a powerful self-contained distress transmitter and once activated it will operate for at least 48 hours. It operates best while floating in water. Although it can be operated on board a vessel or in a life raft, it is not recommended to do so.

The EPIRB can be mounted to the vessel using one of two options:

- Manual bracket, or
- Float-free enclosure



**EPIRB**



**EPIRB in manual bracket**



**Float-free enclosure**

### 3.1 EPIRB controls and indicators

#### 3.1.1 Top view

##### Antenna

Must be vertical and have a clear view of the sky for optimum performance.

##### Strobe lights

Three high intensity LEDs. When EPIRB is activated, the strobe lights flash, providing a visual means of locating the EPIRB.

##### Red LED

*Slow flash:*  
acquiring GNSS location.  
*Rapid flash:*  
EPIRB malfunction.

##### Green LED

Indicates correct/normal function.

##### OFF button

Deactivate EPIRB by lifting the grey cover and pressing the OFF button for >2 seconds.

##### ON button

Activate EPIRB by lifting the red cover and pressing the ON button for >2 seconds.

##### GNSS Antenna (under dome)

Must have a clear view of the sky for optimum performance.

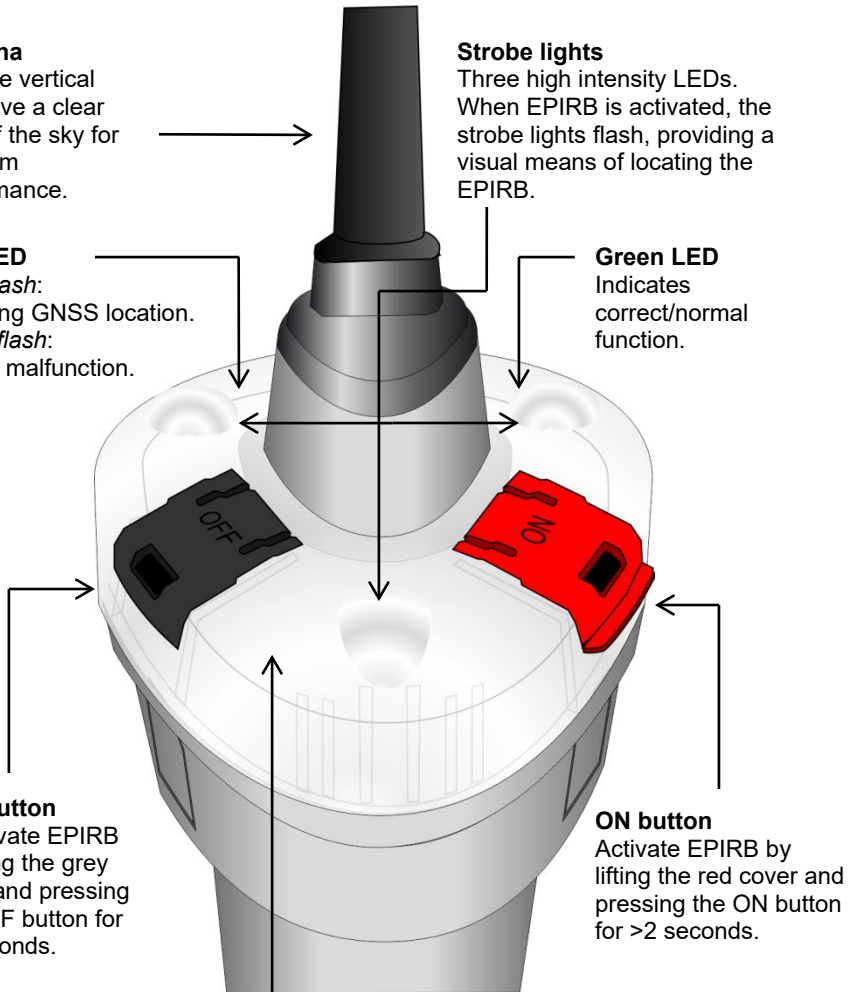

### 3.1.2 Back view

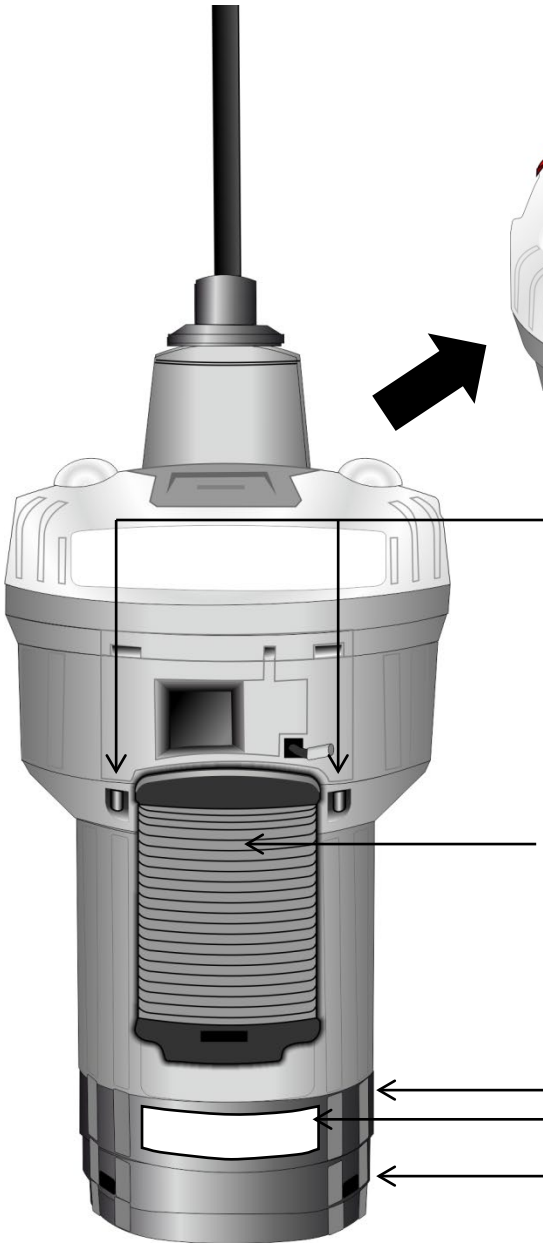

**Test button**  
Initiates self-test (see page 26).

**Sea Contacts**  
Detects when EPIRB is immersed in water and automatically initiates an alert. Sea contacts are disabled when the EPIRB is mounted in the manual bracket, carry-safe bracket or float-free enclosure.

**Lanyard**  
For best operation, leave the EPIRB floating in the sea near the survival craft, as this results in the optimum performance. Use the lanyard to secure the EPIRB to the survival craft (see page 14).

**Battery Case Cover**  
**Battery Expiry Date Label**  
(see page 32)  
**Carry Handle Cover**  
(see page 7)

### 3.2 Carry handle

The carry handle (if fitted) allows hands-free carrying of the EPIRB in an emergency situation.

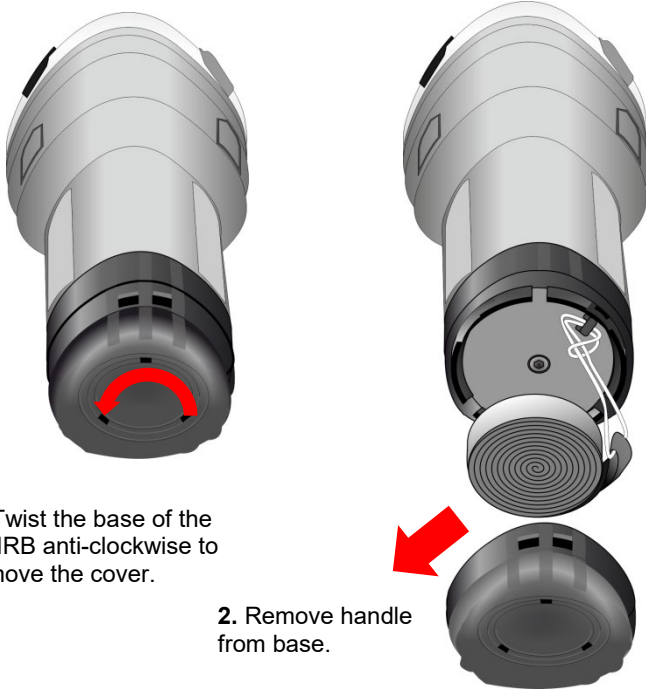

1. Twist the base of the EPIRB anti-clockwise to remove the cover.

2. Remove handle from base.

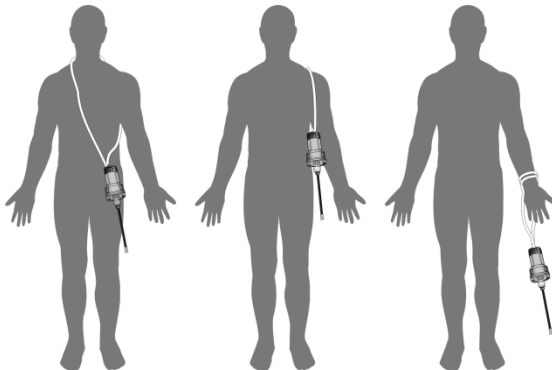

3. Adjust the carry handle to secure the EPIRB across the body, around a shoulder, arm or wrist during emergency evacuation prior to activation.

### 3.3 Manual bracket

If you purchased the manually activated EPIRB variant, this is supplied with a bulkhead-mounting manual bracket.

The manual bracket should be located in plain view near an emergency exit (see page 20).

To prevent accidental activation due to contact with water, the manual bracket contains a magnet which deactivates the sea contacts.

The manual bracket is formed of two parts: a carry-safe bracket which contains the deactivating magnet and a bulkhead dock, which is permanently fixed to the bulkhead of the vessel.

The carry-safe bracket allows the EPIRB to be detached and transported in, for example, a wet grab bag.

**WARNING – The EPIRB will NOT be activated by water while it is in the manual bracket or in its carry-safe bracket. The EPIRB must be removed from all parts of the manual bracket before it will activate in water.**

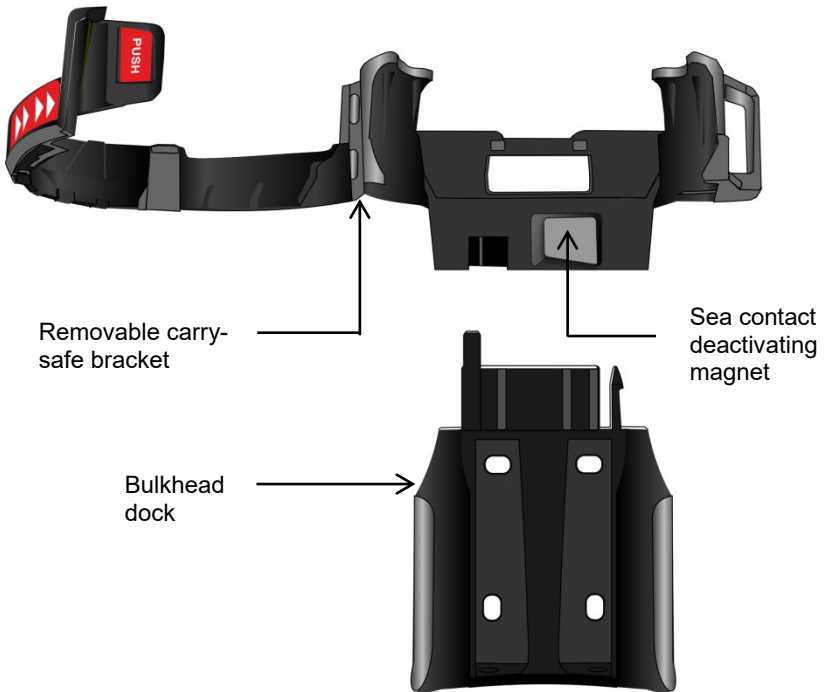

### 3.4 Float-free enclosure

If you purchased the automatically activated variant - also known as the “float-free” version - then your EPIRB is supplied in a fully protective enclosure.

#### 3.4.1 Automatic activation

The float-free enclosure is spring loaded to automatically release the EPIRB if your vessel sinks. This automatic release is controlled by a device called a Hydrostatic Release Unit (HRU) fitted inside the enclosure (see below).

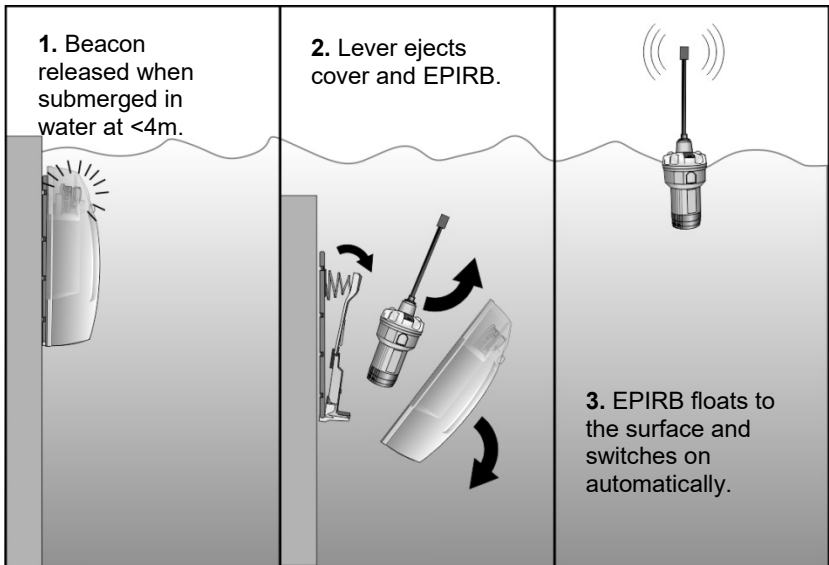

#### 3.4.2 Manual activation

If you need to activate your EPIRB manually, it can be released from the enclosure (see page 12).

To prevent accidental activation due to contact with water, the float-free enclosure contains a magnet which deactivates the sea contacts.

# 4 EMERGENCY PROCEDURE

**An EPIRB is a piece of life saving equipment. Its sole purpose is to call for help.**

**It must only be used in situations of grave and imminent danger.**

**Misuse can involve a severe penalty.**

## 4.1 Abandon ship!

1. If it is safe to do so, release the EPIRB from its mounting bracket or float-free enclosure as described on pages 11 & 12.
2. If your EPIRB is fitted with a carry handle, use it to secure the EPIRB around your shoulder, arm or wrist during the evacuation (see page 7).
3. Take the EPIRB to your life raft.
4. Once the life raft is in the water and clear of the sinking vessel, uncoil the EPIRB's lanyard and tie it to the life raft.
5. Throw the EPIRB overboard so that it floats several metres away from the life raft. The EPIRB will operate automatically.
6. For best operation, leave the EPIRB floating in the sea near the survival craft for optimum performance.

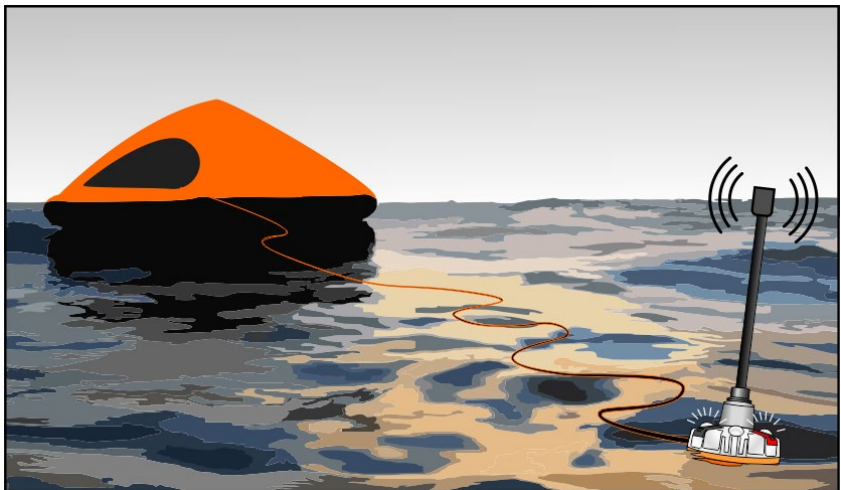

#### 4.1.1 Float-free enclosure

If there has been no time to retrieve the EPIRB from the float-free enclosure during evacuation, it will automatically release itself as the vessel sinks. The EPIRB will float to the surface and start to operate automatically.

The EPIRB is best used to mark the location of survivors, not the accident scene. If possible, and only if it is safe to do so, recover the EPIRB and tie to the survival craft using the lanyard.

#### 4.2 Release from manual bracket

1. Locate the end of the retaining strap on the right hand side of the manual bracket.

2. Push the end of the strap towards the EPIRB and then forwards to release the strap.

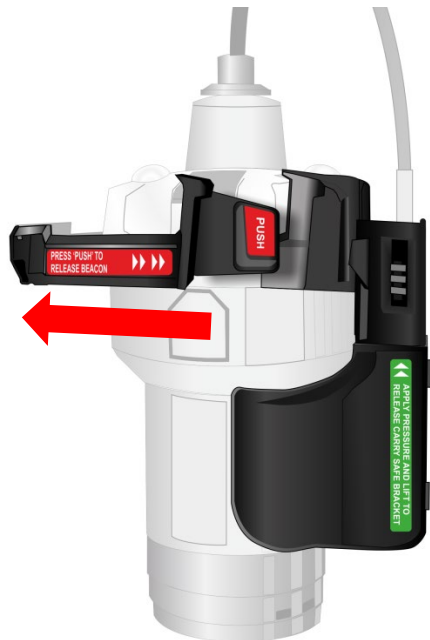

3. Open the strap fully.

4. Firmly pull the EPIRB out of the bracket.

**WARNING – The antenna will spring up when the EPIRB is released. Be careful to avoid eye injury.**



### 4.3 Release from float-free enclosure

1. Locate the locking dial at the top of the enclosure cover.



2. Push the dial in and turn anti-clockwise to the unlocked position.

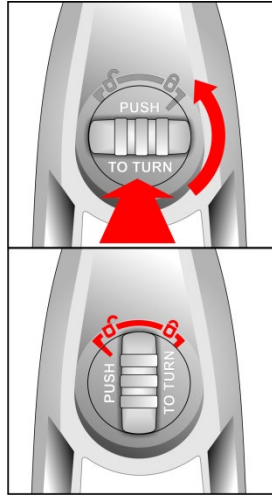

3. Remove the cover by pulling the top away from the bulkhead.

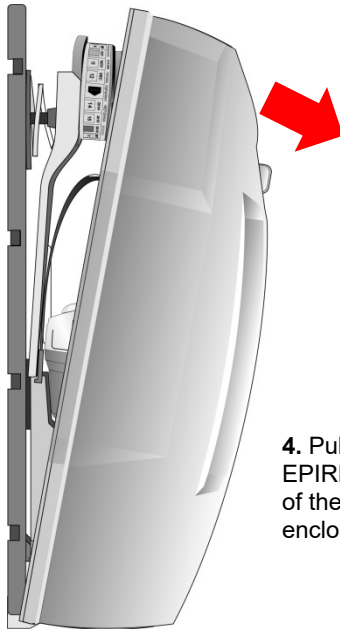

4. Pull the EPIRB out of the enclosure.

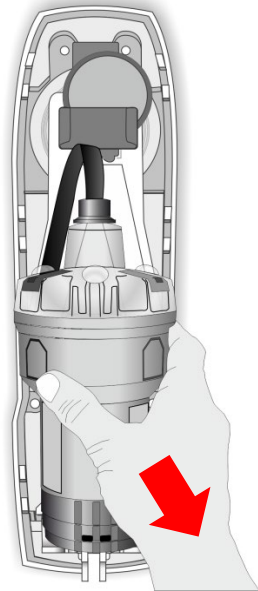

**WARNING – The antenna will spring up when the EPIRB is released. Be careful to avoid eye injury.**

## 4.4 Manual activation

1. Locate the ON button on the top dome under the red cover.



2. Lift the cover, press the ON button for >2 seconds and release.

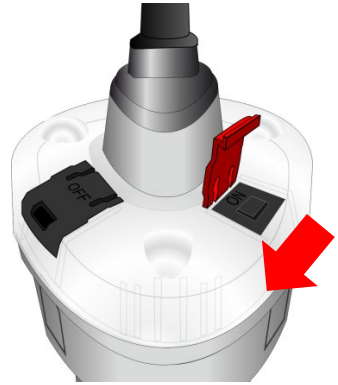

**WARNING – There is a tamper-evident seal over the red cover which will be broken when lifting the cover. If the tamper-evident seal is not intact, the EPIRB may have been activated previously.**

The strobe light will start to flash immediately; however, the EPIRB will not make any distress transmissions for approximately 50 seconds. This allows time to turn off the EPIRB if it has been activated accidentally. When the green indicator starts to flash, distress transmissions have started.

For GNSS-equipped EPIRBs (SafePro AIS and SafePro versions), the EPIRB will also attempt to determine its position using a GNSS satellite constellation. During this process, the RED indicator will flash. Once the position has been determined, the RED indicator will stop flashing.

## 4.5 Optimising onboard performance

The EPIRB is designed and optimised to be used floating in the sea. However, in emergencies when it is not necessary to evacuate the vessel, you may want to deploy the EPIRB onboard.

Find a suitable position for the EPIRB according to the following guidelines:

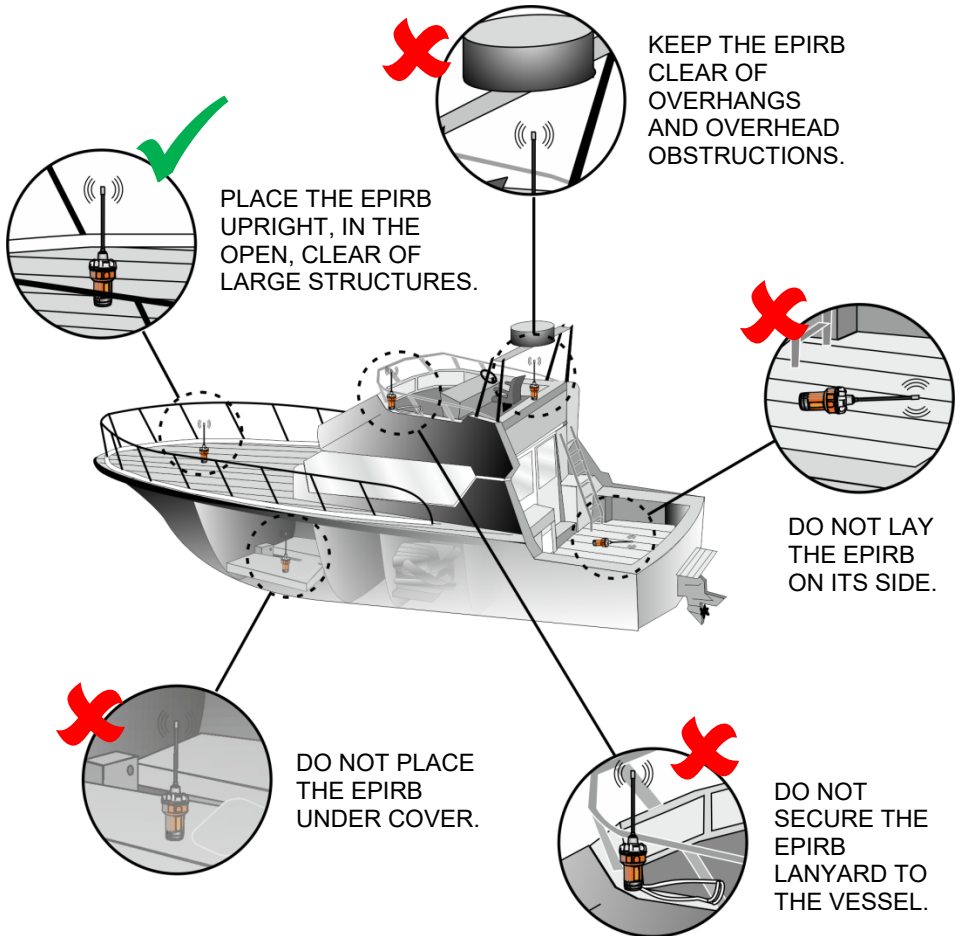

**NOTE: Failure to observe these guidelines may affect whether and how soon an alert is received by the satellite system. Keep the EPIRB upright at all times (hold it if necessary but do not touch the antenna). The high intensity strobe lights may cause discomfort if viewed for long periods.**

## 4.6 Deactivation

Once the EPIRB has been activated for a distress situation, it should not be switched off until the SAR agency directs this.

1. Locate the OFF button on the top dome under the grey cover.



2. Lift the cover, press the OFF button for >2 seconds and release.

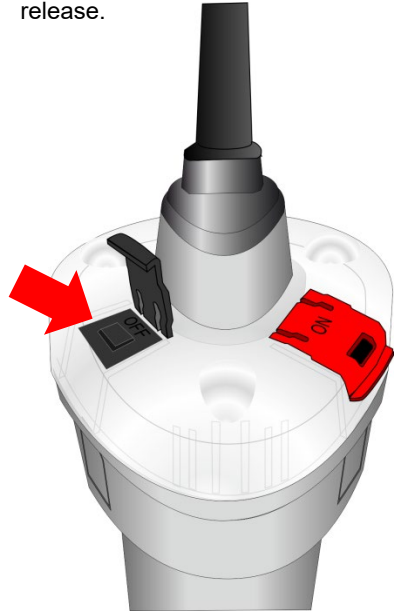

3. The strobe light and green indicator will stop flashing. If any light continues to flash, then check that the sea contacts are dry.

It is important to realise that the only time the EPIRB is completely off is when it is fitted in the manual bracket, carry-safe bracket or float-free enclosure. As soon as it is removed, the EPIRB will turn on automatically if the sea contacts (see page 6) are immersed in water.

Although you can control the EPIRB manually with the ON and OFF buttons, the sea contacts override any manual settings. For the OFF switch to operate properly, the EPIRB must first be dry so that the sea switch is de-activated.

## 4.7 Stowage

### 4.7.1 Manual bracket

1. Locate the right hand end of the manual bracket strap and push it in and forwards to open the strap.



2. Swing the strap open.



3. Slide the EPIRB into the bracket with the lanyard positioned towards the rear until it is held securely.



4. Swing the strap closed and secure the end tab in the retaining slot.



5. Fold over the antenna and locate the tip in the retaining slot behind the EPIRB.

## 4.7.2 Float-free enclosure



1. Locate the locking dial.

2. Push the dial in and turn anti-clockwise to the unlocked position.

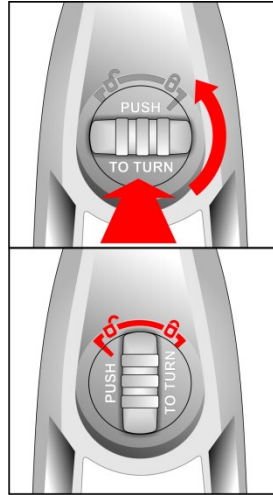

3. Remove the cover by pulling the top away from the bulkhead.

4. Position the EPIRB in the enclosure with the lanyard towards the rear.

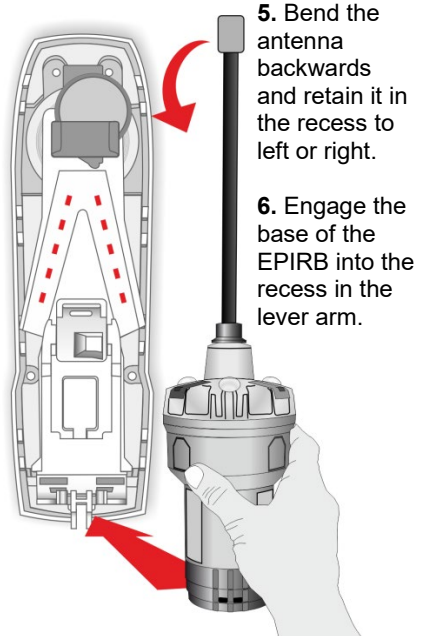
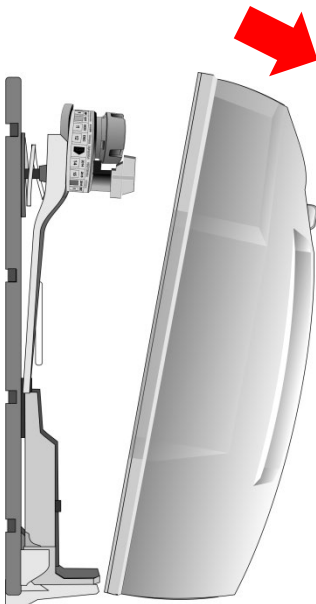

5. Bend the antenna backwards and retain it in the recess to left or right.

6. Engage the base of the EPIRB into the recess in the lever arm.

7. Push the EPIRB into the enclosure to engage the retaining clip.

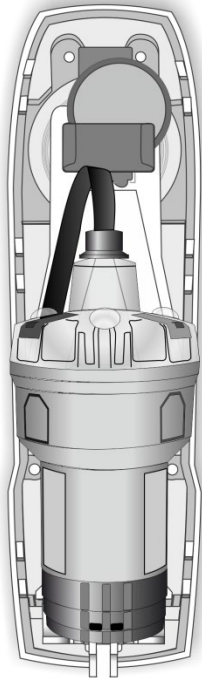

8. Refit cover squarely onto back plate, engaging the guides at the lower end first.

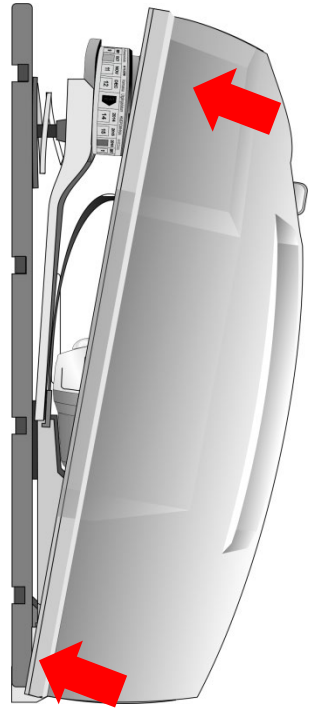

9. Push and rotate dial clockwise to locked position.

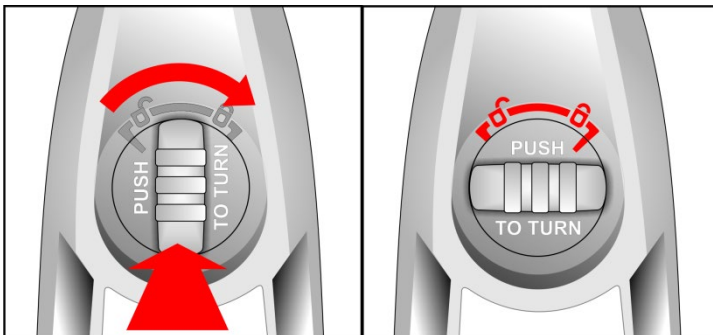

**CAUTION: Failure to fit EPIRB correctly may impair its ability to float free in an emergency.**

## 5 FALSE ALERTS

False alerts are a serious problem for the rescue services. About 90% of EPIRB-initiated distress alerts turn out to be false alerts. If your EPIRB should cause a false alert, follow the instructions below.

### 5.1 Notify rescue services

It is most important that you contact the nearest search and rescue authorities and tell them it was a false alert, so that they can stand down any rescue services. Use any means at your disposal to make contact. Often this can be by VHF radio to the local coastguard or mobile phone if you are within coastal range, but MF/HF DSC and Inmarsat A, B, C, M may also be used.

Useful contacts:

Country	Region	Telephone	What to report
USA	Atlantic / Gulf of Mexico	(757) 398-6390	EPIRB Unique ID (UIN)
	Pacific	(510) 437 3700	Vessel name/ID
	From any location	(800) 323 7233	Date, time & duration Cause of activation
UK	From any location	01326 317 575	Location when activated

### 5.2 Deactivate the EPIRB

1. Deactivate the EPIRB following the procedure on page 15.
2. Re-fit the EPIRB to either the manual bracket or float-free enclosure following the procedure on pages 16 & 17.

### 5.3 Faulty EPIRB

In the unlikely event that your EPIRB develops a fault and will not turn off remove the battery pack from the EPIRB (see page 32).

If this is not possible, cut off or fold down the antenna and then wrap the EPIRB in metal, take it below decks or place in a metal container or locker. Leave the EPIRB in this condition for 3 days until its battery is dead, then refer to page 34 for instructions on returning the EPIRB for servicing.

**WARNING – Take care when handling the antenna. Handle as little as possible.**



# 6 INSTALLATION

## 6.1 Manual bracket

### 6.1.1 Siting

The manual bracket should ideally be sited on a bulkhead in plain view near an emergency exit. When choosing a suitable mounting position you should also consider:

- Ease of access in an emergency, and
- Mount at least 1m from any compass equipment.

### 6.1.2 Mounting procedure

The manual bracket is supplied with four stainless steel screws. The bracket mounts against a flat surface using 4 fixing points. Offer the bracket into the chosen position and mark through the mounting slots and drill four 3mm diameter holes.

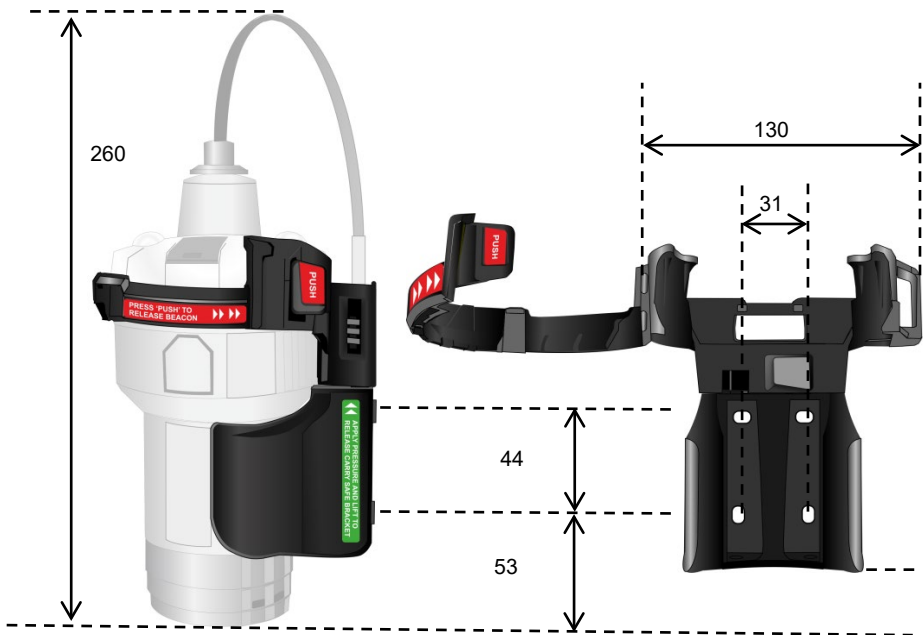

*All dimensions in mm*

### 6.1.3 Mounting instruction plate

The EPIRB is supplied with a self-adhesive instruction plate which has basic visual instructions showing how to operate the EPIRB in an emergency.

Mount the instruction plate next to the EPIRB so that it is easily visible in an emergency.

During vessel maintenance, ensure the plate does not get painted over or cleaned down with strong degreasing solvents.

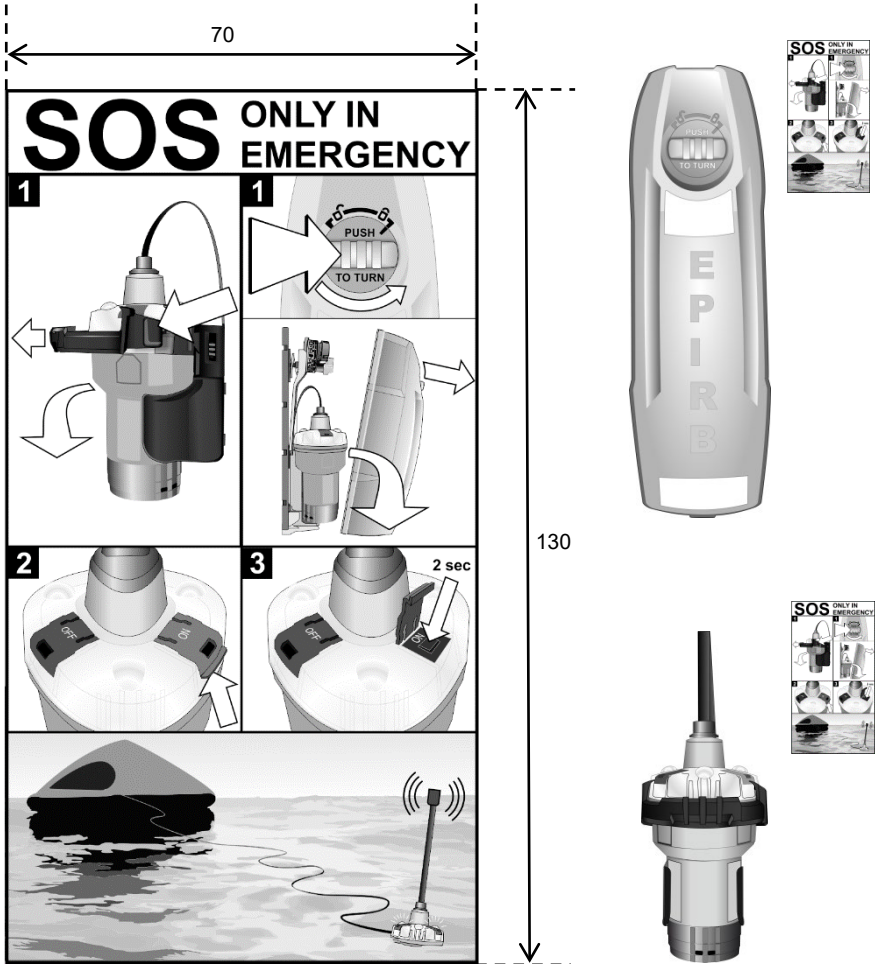

All dimensions in mm

## 6.2 Float-free enclosure

### 6.2.1 Siting

The enclosure should be mounted upright against a vertical bulkhead. Alternatively, it may be mounted horizontally on a flat surface such as a cabin roof. No other orientations are recommended.

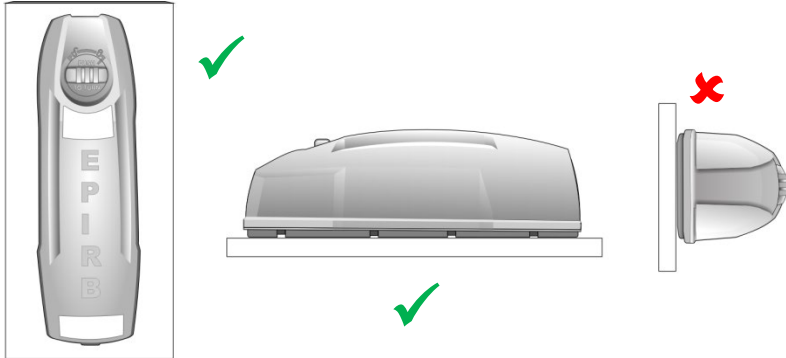

It is critical that you choose a location suitable for automatic deployment. The EPIRB should be sited so that it can float free regardless of the attitude of the vessel during or following capsizing. An expanse of flat surface is required to allow the enclosure lid to eject. The wheelhouse top is a favoured position, although an alternative location should be found if rigging, masts or existing equipment could affect automatic activation. The EPIRB should also be accessible so that it can be taken to the life raft if it becomes necessary to abandon ship.

If the EPIRB is placed on one side of the vessel, or immediately behind the wheelhouse then the likelihood of correct deployment is much reduced.

Use the recommendations below to choose a suitable mounting position:

#### DO:

- Mount on the outside of the vessel's structure as high as possible.
- Mount close to the vessel's navigation position.
- Consider ease of access in an emergency.

#### AVOID:

- Positions with insufficient space for lid ejection and maintenance.
- Positions within 1 m of any compass equipment.
- Positions within 2 m of any radar antenna.
- Positions with high levels of vibration.
- Direct impact from waves.
- Siting where damage is likely.
- Siting close to exhaust fumes, chemical and oil sources.

## 6.2.2 Mounting procedure

Mount the back plate on a flat surface using 4 fixing points. Refer to the illustration for fixing point dimensions or, alternatively, use the back plate of the enclosure as a marking guide. To do this, push down and turn the cover dial anti-clockwise then remove the enclosure cover. Note how the EPIRB fits then remove it to a safe and dry location.

**WARNING – The sea contacts are enabled when the EPIRB is removed from the enclosure.**

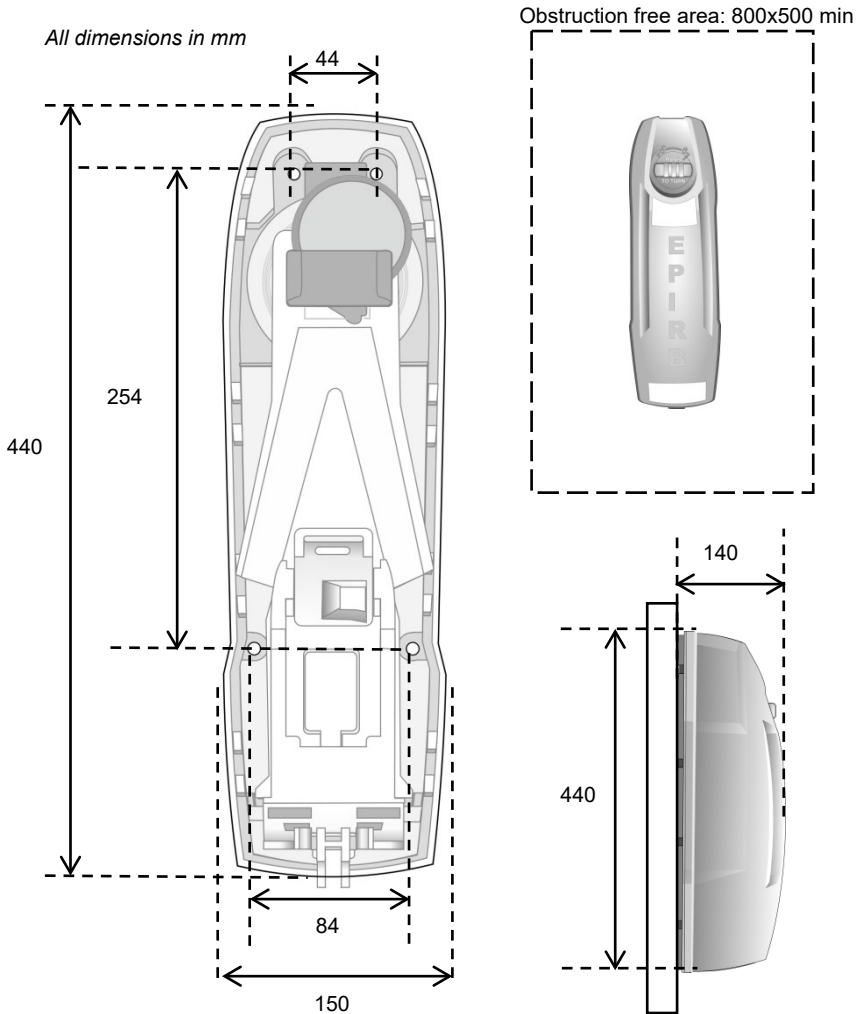

The enclosure is supplied with a set of stainless steel fixings. If the rear of the mounting surface is inaccessible, use self-tapping screws. Offer the back plate into the chosen position and mark through the mounting holes. Drill appropriately sized holes where you have marked. You will need a 4mm hex key to tighten the bolts. Always fit washers under the heads of the bolts to avoid damaging the plastic.

### **6.2.3 Mounting instruction plate**

The EPIRB is supplied with a rigid plate giving visual instructions on how to operate the EPIRB in an emergency. Mount this next to your EPIRB as explained on page 21.

### **6.2.4 HRU expiry date**

It is essential to mark the outside of the enclosure with the expiry date of the Hydrostatic Release Unit (HRU). The HRU has a limited in-service life which starts as soon as it is installed on a vessel. Refer to the HRU documentation to determine the in-service life of the HRU supplied with the enclosure. The expiry date should be marked on the HRU body and copied onto the label on the side of the enclosure. The HRU is marked by cutting out the corresponding dates on its label, as shown on the separate leaflet.

The enclosure should be marked using the alpha-numeric stickers provided, then covered with the clear adhesive label provided. The preferred date format is month and year, for example: JUN 2016.

### **6.2.5 Marking vessel name**

In many countries, it is usual to have your EPIRB programmed by your supplier (see page 3). Your supplier will then mark all the EPIRB labels accordingly. However, if your EPIRB was purchased in the USA, Canada or UK then your EPIRB will have all the necessary markings except for vessel name. In these countries, it is usually left to the customer to mark the vessel name during installation.

It is strongly recommended (and is mandatory in some countries) that the vessel name is marked on the rear of the EPIRB itself and also on the enclosure, if you have one. Use the alpha-numeric stickers provided to mark the vessel name (or its abbreviation) on the top line of the EPIRB's rear label and again on the enclosure label. Protect the markings with a section of the clear adhesive label provided.

1. Pick off required letter (a small knife blade works well),
2. Apply letter to label – repeat until name is complete, and
3. Cover letters with clear label.

# 7 MAINTENANCE

## 7.1 Servicing schedule

As an important item of safety equipment, your EPIRB should be checked regularly according to the following schedule:

Vessel type	Service Interval		
	2 years	5 years	10 years
Leisure voluntary fit	HRU replacement (if fitted) – see page 29	Dealer Safety Check	Dealer Battery replacement
Commercial mandated fit	HRU replacement – see page 29	1st SBM service	2nd SBM service

**NOTE – Shore-based maintenance (SBM) should be carried out in accordance with intervals specified by the flag Administration and not exceeding 5 years. (Please refer to section 7.5 Battery maintenance)**

All servicing must be carried out by an Approved Service Agent. Always call your nearest Approved Service Agent and talk to their customer service department before returning equipment. You can find your nearest Approved Service Agent from:

- The Orolia website: <https://www.oroliamaritime.com>
- Contacting Orolia Maritime direct
- Contacting a distributor of Orolia Maritime products

If the EPIRB has to be returned, the original packaging should be used if possible (see page 34).

Check your beacon for any damage or wear and tear according to the manufacturer's instructions (please refer to <https://www.oroliamaritime.com> for further details).

## 7.2 Self-test & inspection

The EPIRB has a built-in self-test capability that can be used as a confidence check. This self-test confirms that the battery is healthy, that the GPS receiver and distress transmitters are functional and that the strobe light is operational. The short self-test should be performed **monthly** and not more than 12 times per year. It should be performed during the first 5 minutes of the hour to minimise disturbance on the emergency channel.



### 7.2.1 Short self-test

1. Press the TEST button for 2 seconds and then release.
2. The green LED will flash once to confirm the short self-test has started.

**NOTE – The green LED will also flash when the EPIRB makes a transmission during normal operation or during a self-test.**

3. The EPIRB performs internal checks.
4. The result of the self-test is indicated by the flashing of the white strobe lights or the red LED according to the following table. The number of times the strobe lights flash is an indication of the accumulated time the battery has been in use.

Indicator	No. of flashes	Meaning
Strobe	3	Self-test passed – minimal battery usage EPIRB is OK to use
Strobe	2	Self-test passed – medium battery usage EPIRB is OK to use; 48 hours operation remaining
Strobe	1	Self-test passed – but battery usage exceeds recommended limit. Change the battery to ensure 48 hours of operation in an emergency.
Red LED	1	Self-test failed. Arrange service by an Approved Service Agent

**NOTE – Regardless of the battery state, the EPIRB should always be activated in an emergency – it may still be capable of generating an alert.**

## 7.2.2 Long self-test (GNSS variants only)

A long self-test consumes battery life and can only be performed 20 times per battery replacement. You should only run a long self-test if you suspect the GNSS receiver is faulty. Choose a location where the EPIRB may be expected to acquire a GNSS satellite signal – see page 14.

The long self-test sequence proceeds as follows:

1. Press the TEST button for 10 seconds until the green LED lights for 2 seconds and then release. If the green LED is followed by a long flash from the red LED, the maximum number of long self-tests has been exceeded and self-test is immediately terminated.

**WARNING – If a rapid sequence of Red LED flashes occurs, the TEST button has been pressed for too long. Release pressure on the button, wait 5 seconds, and then repeat the procedure.**

**If you continue to apply pressure to the button, the beacon remains in a fault condition, the self-test will not be activated, and it will drain current from the battery.**

2. A short flash of the red LED indicates that the GNSS receiver is searching for satellite signals and calculating a valid position fix.
3. Once a valid position has been determined, a 406 MHz test transmission containing the position is sent out. If the EPIRB has AIS capabilities, a similar test transmission is sent out using the AIS frequencies.
4. The result of the self-test is indicated by the flashing of the white strobe lights or the red LED according to the following table. The number of times the strobe lights flash is an indication of the number of long self-tests remaining.

Indicator	No. of flashes	Meaning
Strobe	3	Long self-test passed – less than 10 tests performed.
Strobe	2	Long self-test passed –10 or more tests performed
Red LED	1	Self-test failed – no position found

If the EPIRB passes short self-test but fails the long self-test, it is advisable to have it serviced by an Approved Service Agent. It will still generate an alert in an emergency but it may not provide precise position information. This may delay a rescue as the possible search area is much larger.



**WARNING – While the EPIRB is running this self-test it cannot generate a distress alert. It is therefore recommended that this self-test is performed only under conditions where an emergency is unlikely to arise.**

If necessary, the self-test may be terminated at any time by holding down the TEST button for 10 seconds.

## 7.3 Mechanical inspection

It is recommended that a monthly check is carried out to inspect the EPIRB and its mountings visually for deterioration or damage.

On the EPIRB itself check the following:

- Inspect the EPIRB for any obvious damage
- Check that the lanyard is not tied to the vessel structure
- Check the battery is within its expiry date
- Check that the sea contacts are clean and free from paint or grease
- Check that the antenna has not been damaged or creased and that it erects to a vertical position when released.
- Check that the beacon is stored such that no pressure can be applied to the TEST button, and that the covers on the ON and OFF buttons are closed to ensure the beacon cannot be activated inadvertently.

If you have a manual bracket:

- Check the EPIRB is correctly fitted and is secure in its bracket
- Check that the two halves of the bracket are securely clipped together

If you have a float-free enclosure:

- Check the HRU is within its expiry date
- Confirm the cover can be easily removed
- Ensure the EPIRB base is correctly fitted into the D-shaped recess and that the antenna is correctly stowed

If the EPIRB or its mounting needs cleaning, then this should be done using warm soapy water and a damp (not wet) cloth. Do not use strong detergents or solvents.

Due to the impact of the marine environment on vessel equipment stored or regularly exposed to often harsh climate conditions, Orolia strongly recommends owners obtain a five- year external health check at an authorised Orolia Service Centre. Locations of authorised service dealers can be found at <https://www.oroliamaritime.com> .

**WARNING – Do not paint the EPIRB or its mounting. Do not clean with detergents or solvents. It is recommended that the EPIRB and its mounting are removed during vessel cleansing or painting operations.**

## 7.4 HRU replacement

If you have an EPIRB mounted in a float-free enclosure, then it contains a Hydrostatic Release Unit (HRU). This has a replacement interval which is marked on the HRU and on the float-free enclosure (typically every 2 years – see page 25).

**WARNING – Failure to replace the HRU at the required replacement interval may result in it not actuating correctly and failing to release the EPIRB in an emergency.**

You can obtain a replacement HRU at a local marine store; ask for Orolia HRU Replacement Kit (23-145A). The kit is complete with HRU and all required accessories including an instruction sheet.

The HRU replacement procedure is as follows:

1. Locate the dial on the enclosure cover, press in and turn dial anti-clockwise to the unlocked position and remove the cover (see page 12).
2. Remove the EPIRB from the lever arm and stow it in a dry place (see page 12).

**WARNING – The EPIRB will activate if the sea contacts (see page 6) come into contact with water.**

3. While holding down the lever arm to take up the force of the spring, push the HRU back then slide upwards out of the slot in the lever arm. Remove the HRU and slowly release the lever arm.

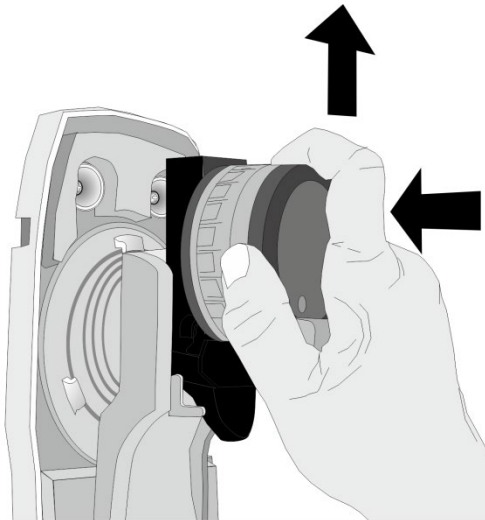

- Assemble the HRU:

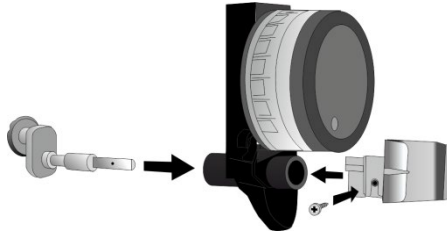

**HRU Replacement Kit (23-145A)**

- Mark the HRU and enclosure cover with the new expiry date.

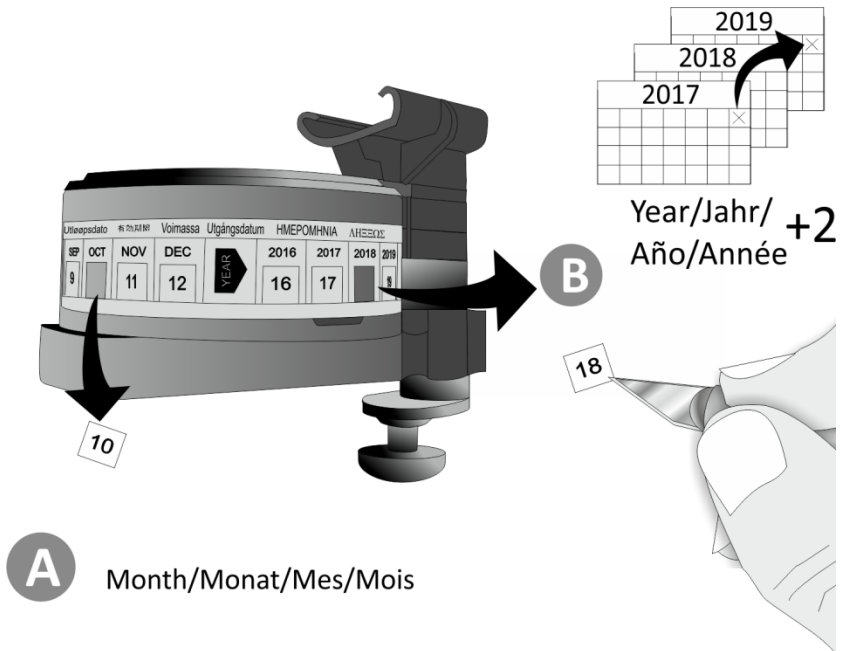

- Position the HRU in the hole in the lever arm and push lever arm down. Engage the HRU flange into the enclosure back plate by pushing back and sliding down. Look under the spring and check that the flange is correctly seated.

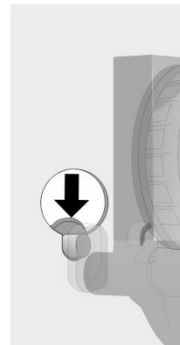
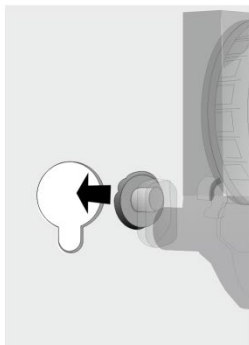
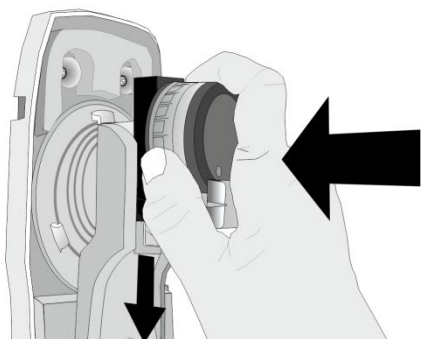

7. Re-fit the EPIRB as shown on page 17.
8. Refit the cover and secure by turning the dial clockwise to the locked position. Check that the cover is seated correctly and is secure.
9. Update expiry date on autohousing label. Remove or cover existing HRU expiry date. Use sheet (A) to apply new expiry date (as in Step 5) and then protect new date with clear media (B or C).

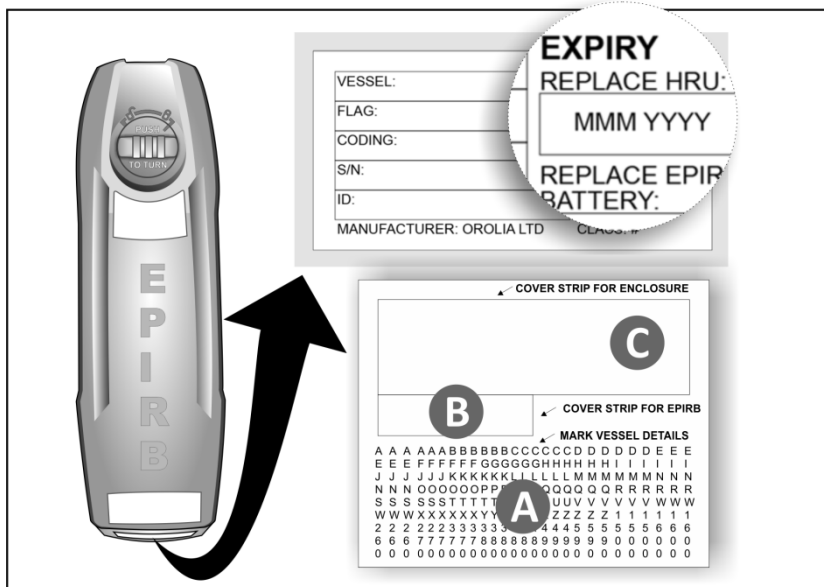

## 7.5 Battery maintenance

The EPIRB is powered by a replaceable battery pack (Orolia Part No. 23-270). This is a non-rechargeable sealed unit containing three 3V battery packs with each pack containing two 1.5V lithium iron disulphide cells.

The battery pack needs to be replaced if the beacon has been activated or every 10 years or by its expiry date. If the EPIRB is covered by SOLAS regulations, then it will need to be changed **before the expiry date** or as required by any local or ship registration requirements (see schedule on page 25).

The battery pack expiry date is marked on the battery pack cover (under the lanyard) and, if you have a float-free enclosure, it is also marked on the base of the enclosure cover. The battery expiry date should be checked regularly. You should also replace the battery:

- If the EPIRB has been used in an emergency situation, **or**
- When a false activation has occurred and a self-test indicates that less than 48 hours operating time remains. It is recommended to replace the battery after any false activation.

Lithium batteries have special disposal requirements. Never incinerate a lithium battery. Never dispose of one at sea. Your Approved Service Agent will be able to deal with battery disposal.

**NOTE – Regardless of the battery state, the EPIRB should always be activated in an emergency – it may still be capable of generating an alert.**

### 7.5.1 Battery replacement

If you need to replace the battery pack, please contact your local Approved Service Agent.

### 7.5.2 Battery removal

To remove the battery pack:

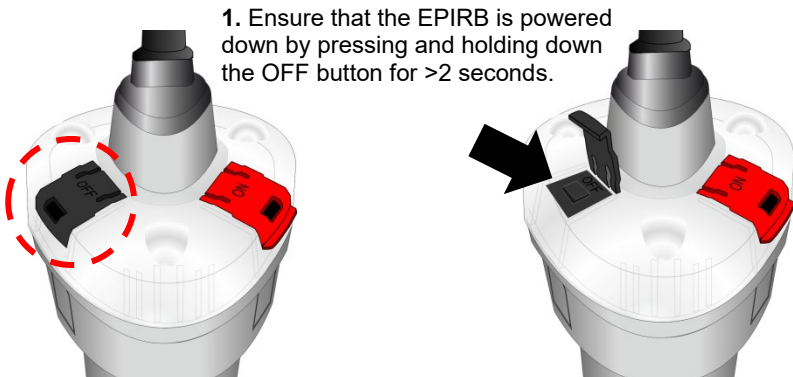

2. Twist base of EPIRB anti-clockwise.

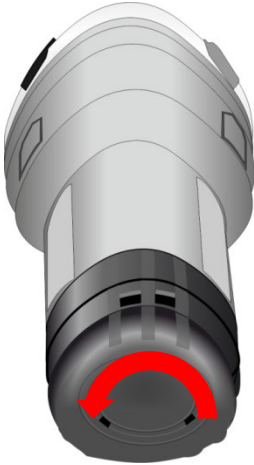

3. Remove cover.



4. Untie and remove carry handle (if fitted).

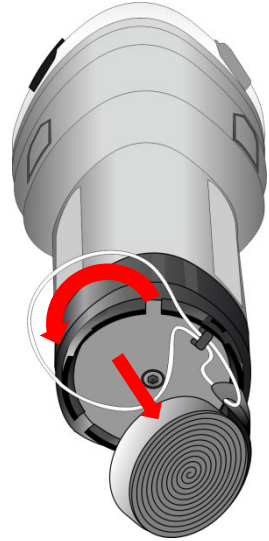

5. Using a 4mm hex key, unscrew retaining bolt until loose. Do not remove at this stage.

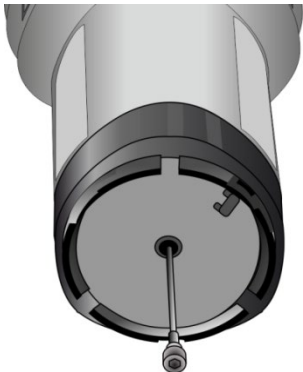

6. The battery pack is held in place by two waterproof seals. To release the battery, pull the cover or screw firmly.

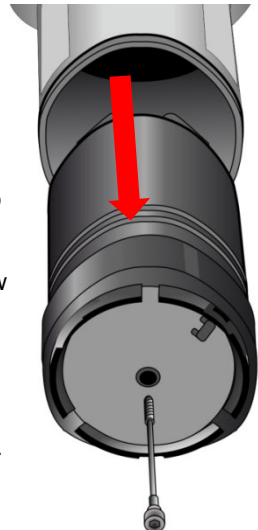

7. Remove the screw completely and dispose of the battery.

**NOTE – These instructions are provided to allow you to disable a faulty EPIRB (see page 19). To replace a battery pack, please contact your local Approved Service Agent.**

## 7.6 Transportation

For transportation purposes, the hazardous materials classification of EPIRB units and batteries is as follows:

<b>Package contents</b>	<b>Classification</b>
EPIRB without battery pack	Non-hazardous
EPIRB and uninstalled battery pack	Class 9 hazardous unless packed in accordance with special provisions
EPIRB with installed battery pack	Class 9 hazardous
Battery pack only	Class 9 hazardous

For further information, please refer to the Orolia website:

<https://www.oroliamaritime.com>.

## 7.7 GMDSS inspections

If your vessel is subject to GMDSS regulations then you can expect to get regular visits from ship surveyors enforcing national legislation. They will check the expiry dates and activate the EPIRB to prove that it is operational and they will read the identity message stored inside the EPIRB to check that you have registered it properly.

Leisure vessels are not subject to these inspections. However, in some countries, passenger and fishing vessels are covered by the legislation.

## 8 END OF LIFE STATEMENT

At the end of the EPIRB's useful life, it is vital that the battery pack be removed from the main unit to prevent false alarms. False alarms cause expensive disruption to Search and Rescue services and may endanger lives as a consequence. It is also necessary that the EPIRB and its battery pack be disposed of in a manner that does not present a threat of environmental damage.

### 8.1 Disposal

The Waste Electrical and Electronic Equipment (WEEE) Directive aims to minimise any adverse impact of electronic equipment on the environment, both during the product lifetime and when it becomes waste. Within the European Union this legislation is mandated by Directive 2012/19/EU, and there is similar legislation in most other continents. The directive applies to all electronic products such as IT, household appliances, portable electronics etc., and imposes requirements to collect, treat, recover and recycle each product at its end of life. Electronic end-user products must also carry a WEEE label (as below) and recovery and recycling information has to be provided to the recycler.



This EPIRB product contains traces of lithium in the battery pack. In addition it may contain lead and brominated flame retardants (BFRs), both in the housing material and circuit boards.

In keeping with the directive, Orolia strongly recommends that this EPIRB product and its battery pack be disposed of in a sensible and considerate manner. For example, do not simply discard the product in the domestic waste. Instead take it to a civil recycling facility, or contact Orolia for advice.



# 9 TECHNICAL SPECIFICATION

406 MHz transmitter	Frequency	406.040 MHz $\pm$ 1 kHz
	Power output	5 W nominal
	Modulation	Phase (16K0G1D)
121.5 MHz transmitter	Frequency	121.5 MHz $\pm$ 3.5 kHz
	Power output	70 mW nominal
	Modulation	Swept tone AM (3K20A3X)
AIS transmitter	Frequencies	161.975 MHz (AIS1) 162.025 MHz (AIS2)
	Power output	1 W EIRP
	Modulation	Phase (16K0GXW)
GNSS receiver	Constellations	GPS, GLONASS, Galileo
	Frequencies	1575.42 MHz (GPS, Galileo) 1602.00 MHz (GLONASS)
	Sensitivity	-167 dBm minimum
	Satellites tracked	72 channel
Strobe light	Type	3 high intensity LEDs
	Light output	0.75 cd minimum
	Flash rate	23 flashes per minute
Battery	Type	Lithium iron disulphide
	Operating life	48 hours minimum
	Shelf life	10 years typical in service
Environment	Operating temperature	-20 °C to +55 °C (-4° F to +131° F)
	Storage temperature	-30 °C to +70 °C (-22° F to +158° F)
	Automatic release depth	4 m maximum
Dimensions (EPIRB)	Weight	710g
	Height/Width/Depth	425 x 105 x 105 mm (incl. antenna)
	Length of antenna	225 mm
Dimensions (Manual bracket)	Weight	110 g
	Height/Width/Depth	135 x 125 x 125 mm
Dimensions (Float-free enclosure)	Weight	1075 g
	Height/Width/Depth	415 x 135 x 135 mm
Standards	COSPAS-SARSAT	C/S T.001 C/S T.007
	Europe	MED (wheelmark)
	USA	USCG & FCC
	International standards	IEC 61097-2 IEC 60945 incl. Corrigendum1 IEC 61108-1 (GNSS variant) RTCM 11000.4 Industry Canada RSS-287 AS/NZS 4280.1
	IMO regulations	A.662(16); A.694(17); A.810(19); A.814(19)

# 10 PRODUCT WARRANTY

## 10.1 Orolia Warranty Registration

**Congratulations on purchasing your beacon. As standard, your unit has a one year (12 months) warranty from the date of purchase shown on your invoice, however, this can be extended by a further four years by simply registering your unit on-line within 90 days of purchase at: <https://www.oroliamaritime.com> then follow the REGISTER WARRANTY link at the top of the page.**

## 10.2 Warranty Statement

Subject to the provisions set out below Orolia warrants that this product will be free of defects in materials and workmanship for a period of up to five years (see above) from the date of purchase. Orolia will not be liable to the buyer under the above warranty:

- For any defect arising from fair wear and tear, wilful damage, negligence, abnormal working conditions, failure to follow Orolia's instructions (whether oral or in writing) including a failure to install properly and/or to use batteries recommended and/or supplied by Orolia, misuse or alterations or repair of the product by persons other than Orolia or an Approved Service Agent.
- For parts, materials or equipment not manufactured by Orolia in respect of which the buyer shall only be entitled to the benefit of any warranty or guarantee given by the manufacturer to Orolia;
- For the battery storage life which is specifically excluded from this warranty;
- If the total price for the product has not been paid.

**THE LIMITED WARRANTY STATED ABOVE IS EXCLUSIVE AND IN LIEU OF ANY OTHER WARRANTY, EXPRESS OR IMPLIED, INCLUDING BUT NOT LIMITED TO ANY IMPLIED WARRANTY OF MERCHANTABILITY OR FITNESS FOR A PARTICULAR PURPOSE.**

Orolia will not be liable for indirect, special, incidental or consequential damages of any kind sustained from any cause. In no event shall Orolia be liable for any breach of warranty or other claim in an amount exceeding the purchase price of the product. This warranty does not affect any statutory rights of the consumer. In order to be valid, claims must be made under the above warranty in writing as soon as practicable after discovery of the defect or failure and within the warranty period referred to above. Proof of purchase will be required. The claim should be sent together with the product in question to the address set out below or to an Approved Service Agent. Following a valid warranty claim Orolia shall be entitled to repair or replace the product (or part) in question free of charge, or at Orolia's sole discretion to refund to the buyer the price of the product (or a proportional part of the price). Orolia shall

not be liable to a buyer who is not a consumer for any other loss or damage (whether indirect, special or consequential loss of profit or otherwise) costs, expenses or other claims for compensation which arise out of or in connection with this product. In the case of a consumer, Orolia shall only be liable where other loss or damage is foreseeable.

Nothing shall limit Orolia's liability for death or personal injury caused by its negligence. This warranty is to be interpreted under English law.

All enquiries relating to this warranty or Approved Service Agents should be sent to:

Orolia Ltd,  
Silver Point,  
Airport Service Road,  
Portsmouth,  
Hampshire,  
PO3 5PB  
UK

**Telephone:** Int + 44 (0) 23 9262 3900

**Fax:** Int + 44 (0) 23 9262 3998

**Web:** <https://www.oriolamaritime.com>

**Email:** [customer.service@orolia.com](mailto:customer.service@orolia.com)

# 11 HOW DOES IT WORK?

When you activate the EPIRB, its on board transmitters start broadcasting distress signals at several frequencies:

- A 406 MHz alert signal can be received by the Cospas-Sarsat satellite system (see page 40). Ground stations track these satellites and process the distress signals to obtain a location using Doppler location techniques (see <https://www.cospas-sarsat.int/en/21-embedded-articles/230-doppler-processing> ).
- A 121.5 MHz transmission can be detected by overflying aircraft and Search & Rescue (SAR) homing receivers.
- For EPIRB models equipped with AIS (SafePro AIS), an additional transmission operates at 162 MHz. The AIS message includes the unit ID, GPS position and a simple text message and is repeated 8 times per minute using an 'Impolite AIS Protocol' giving it priority over other AIS signals in the vicinity. This signal will typically be received by vessels with VHF AIS antennae out to a four-mile range (typical).
- With EPIRB models equipped with a GNSS (Global Navigation Satellite System) receiver (SafePro AIS / SafePro), the current position is transmitted as part of the distress signal. GNSS systems require a clear view of the sky in order to work effectively, because the receiver needs signals from several satellites to calculate its position. If the GNSS receiver within the EPIRB cannot determine its position, it "fails safe" - it does not transmit an inaccurate position - but instead sends information to indicate that no position is available. Position information is then dependent on the orbiting satellite system.

The transmissions will continue for a minimum of 48 hours and continue until the battery is exhausted.

## 12 COSPAS-SARSAT SATELLITE SYSTEM

The International Cospas-Sarsat Programme is a satellite-based search and rescue distress alert detection and information distribution system, best known for detecting and locating emergency beacons activated by aircraft, ships and hikers in distress. Since its launch in 1982, Cospas-Sarsat has helped to save over 40,000 lives.

### 12.1 The Search And Rescue (SAR) process

The following diagram of the Cospas-Sarsat Ecosystem shows the 5 critical stages to the search and rescue process.



1. The process begins with the activation of a distress beacon (EPIRBs for maritime use, PLBs for personal use and ELTs for aviation use) in an emergency situation, sending out a 406 MHz signal.
2. The Cospas-Sarsat satellite system picks up the signal and transmits it back to a ground receiving station on Earth. These are called Local User Terminals or LUTs.
3. The LUT processes the signal to generate a distress alert and relays it to a Mission Control Center.

4. The Mission Control Center receives the alert and relays this with location information to a Rescue Coordination Center, often looking up the unique beacon ID number to gather information about the registered owner.
5. The Rescue Coordination Center alerts the appropriate emergency response teams to deploy a rescue effort.

The Cospas-Sarsat System today includes two types of satellites: Low-altitude Earth orbit (LEOSAR) and Geostationary Earth orbit (GEOSAR), each contributing respective advantages to detection and location of distress beacons that have been activated.

The LEOSAR system can locate a beacon without the aid of a GPS, but the LEOSAR satellites only view a small part of the Earth at any given time and may require multiple passes of a satellite resulting in delay to the search and rescue process.

The GEOSAR system constantly covers the entire Earth except the high-latitude (e.g., polar) regions receiving distress alerts across most of the globe. However, it cannot locate the beacon unless the location is encoded in the beacon's message from a local navigation receiver such as a GPS.

MEOSAR is an advanced next generation satellite-based technology that is revolutionising the Cospas-Sarsat ecosystem. Once complete, MEOSAR will put over 6 times the number of existing Cospas-Sarsat satellites into orbit, resulting in greater global coverage and more position accuracy.

## **12.2 Global Navigation Satellite System (GNSS)**

GNSS systems such as GPS, Galileo and GLONASS can be used by the GNSS equipped EPIRB to determine its position with high accuracy. Advanced GNSS data processing results in fast detection of positioning coordinates and enhances the accuracy of the emergency location.

## **12.3 MEOSAR Compatibility Explained**

SafePro AIS, SafePro and Safe EPIRBs are fully compatible with the Early Operation Capability (EOC) and Full Operating Capability (FOC) MEOSAR systems and will benefit from the improved detection and location capabilities of this new infrastructure.

The International Cospas-Sarsat Programme initiated the development and deployment of a Medium-altitude Earth Orbiting Satellite Search and Rescue (MEOSAR) System in 2004 to complement and eventually replace the Low-altitude Earth Orbit SAR Satellites (LEOSAR) deployed from the 1980s through 2010.

The MEOSAR system employs SAR repeaters on Global Navigation Satellite Systems (e.g., GPS, Galileo, and Glonass) and provides improved detection, and independent position locating capability for emergency position indicating radio beacons (EPIRBs), emergency locator transmitters (ELTs) and personal locator beacons (PLBs).

The MEOSAR system should attain Full Operating Capability (FOC) in 2020, with the anticipated availability of enhanced second generation 406 MHz Distress Beacons shortly before or after FOC.

A parallel effort to design the next generation Cospas-Sarsat distress beacon is also underway. The Second Generation Cospas-Sarsat Beacon (SGB) will be designed to work with the MEOSAR component to provide increased detection, return link service, enhanced data fields and is targeted for introduction at MEOSAR FOC, or shortly thereafter.

Further information on MEOSAR and the Cospas- Sarsat network is available at the Orolia website <https://www.oriamaritime.com> .

## 13 HOW TO REGISTER YOUR EPIRB

EPIRB registration is now available on-line. This is the preferred method of registration. The website address for various countries is given below:

Country	Website address
Australia	<a href="http://www.amsa.gov.au/beacons">www.amsa.gov.au/beacons</a>
New Zealand	<a href="http://www.beacons.org.nz">www.beacons.org.nz</a>
UK	<a href="http://forms.dft.gov.uk/mca-sar-epirb">forms.dft.gov.uk/mca-sar-epirb</a>
USA	<a href="http://www.beaconregistration.noaa.gov">www.beaconregistration.noaa.gov</a>
Other (COSPAS-SARSAT)	<a href="http://www.406registration.com">www.406registration.com</a>

Go to the registration website for your country/flag state and follow the instructions.

The COSPAS-SARSAT website provides registration details for many countries: [www.cospas-sarsat.int](http://www.cospas-sarsat.int)

In case on-line registration is not available, three registration forms are provided: one to be completed immediately and two are for future use. These forms are pre-printed with your EPIRB's identity; all you have to do is complete details of your vessel and provide contact numbers. Wherever possible the forms are also pre-printed with the correct mailing address and a faxback number. If your form does not have a mailing address, contact your supplier. When you have completed the form, you can choose to fax it or mail it.

It is usual to receive confirmation when you register. In Australia, the UK and USA you will also receive a "Decal" sticker which you must fit to the EPIRB itself. The Decal is proof of registration - not having a Decal is an offence.

Useful registration contacts are:

### **USA Sarsat Beacon Registration**

NOAA/Sarsat Beacon Registration,  
NSOF, E/SP053,  
1315 East West Highway,  
Silver Spring,  
MD 20910-9684.  
Tel 888 212 7283  
Fax 301 817 4565

### **UK EPIRB Registry**

HM Coastguard (Southern),  
Pendennis Point,  
Castle Drive,  
Falmouth,  
TR11 4WZ.  
Tel 01326 211569  
Fax 01326 319264

## 13.1 Emergency contact

It is VITAL that the emergency contact information is accurate, particularly regarding the telephone number, as this will be used to validate an alert. Only if the beacon registration and approximate location details can be confirmed will USCG (United States Coast Guard) launch an immediate rescue, otherwise there will be a delay whilst further alerts from the same source are received and verified.



## 13.2 Registration Information for Australia & New Zealand

For Australia and New Zealand, the preferred method of registration is online at [www.amsa.gov.au/beacons](http://www.amsa.gov.au/beacons) and [www.beacons.org.nz](http://www.beacons.org.nz) respectively.

### 13.2.1 Advice for EPIRB purchase or transfer

Registration of 406 MHz satellite EPIRBs with the EPIRB Registration Section of the national authority\* is mandatory because of the global alerting nature of the COSPAS-SARSAT system. In New Zealand, registration is mandatory for commercial vessels.

The information provided in the registration is used only for search and rescue purposes.

Fill in the owner registration card immediately upon completion of the sales transaction. Mail, fax or email the registration card to the national authority\* immediately. Registration cards are also available on line.

If the beacon is to enter service immediately, complete the registration card and fax or email the information to the relevant national authority\*.

If the beacon is being transferred to a new owner, the current owner is to inform the national authority\* by email, facsimile, letter or telephone of the name and address of the new owner.

The new owner of the beacon is required to provide the national authority\* with the information as shown on the registration card.

This obligation transfers to all subsequent owners.

\*The national authority is the Australian Maritime Safety Authority or the Rescue Co-ordination Centre New Zealand, as appropriate. Contact details are:

Australian Maritime Safety Authority (AMSA)	Beacon Registration Section, Australian Maritime Safety Authority, GPO Box 2181, Canberra City, ACT 2601 Online registration: <a href="http://www.amsa.gov.au/beacons">www.amsa.gov.au/beacons</a> Fax: +61 2 9332 6323 Local 1800 406 329 Email: <a href="mailto:ausbeacon@amsa.gov.au">ausbeacon@amsa.gov.au</a> Phone: +61 2 6279 5766 or 1800 406 406
Rescue Co-ordination Centre New Zealand (RCCNZ)	Rescue Co-ordination Centre New Zealand PO Box 30050, Lower Hutt 5040 Online registration: <a href="http://www.beacons.org.nz">www.beacons.org.nz</a> Fax: +64 4 577 8041 Email: <a href="mailto:406registry@maritimenz.govt.nz">406registry@maritimenz.govt.nz</a> Phone: +64 4 577 8042

### 13.3 Online warranty registration

Please complete the online warranty registration form:

<https://www.oroiamaritime.com/marine-beacon-registration/>

Failure to do this may delay any future warranty claim.

### 13.4 Radio licence

An EPIRB is a radio transmitter and must therefore be added to your radio licence. If you have been allocated a radio call sign, then you already have a radio licence for your VHF or MF radio set. You should update your licence to include your EPIRB. For further details see your licence or use these contact numbers:

<b>USA</b>	Website: <a href="http://www.fcc.gov/Forms/Form605/605.pdf">www.fcc.gov/Forms/Form605/605.pdf</a>  <i>Federal Communications Commission 445 12<sup>th</sup> Street SW Washington, DC 20554</i>	Tel: 888 225 5322
<b>UK</b>	Spectrum Licensing Riverside House 2a Southwark Bridge Road London, SE1 9HA  Website: <a href="http://services.ofcom.org.uk">services.ofcom.org.uk</a>	Tel: 0300 123 1000 or 020 7981 3131 Fax: 020 7981 3235 Textphone * 0300 123 2024 or 020 7981 3043 E-mail: <a href="mailto:spectrum.licensing@ofcom.org.uk">spectrum.licensing@ofcom.org.uk</a>

\*Please note that these numbers only work with special equipment used by people who are deaf or hard of hearing.

### 13.5 Sale or transfer

EPIRBs registered in Australia, Canada, UK and USA do not need to be re-programmed when transferred to a new vessel. Simply complete another registration form to inform the authorities of the transfer. Use one of the spare forms provided or contact Orolia for a blank form.

For most other countries, the EPIRB must be re-programmed with either the new vessel's Maritime Mobile Station Identity (MMSI) or its radio call sign, whichever is required by the country controlling the new vessel.

Since the EPIRB identity contains a country code, it follows that changing the flag state of the vessel also means the EPIRB must be re-programmed. Programming can be carried out at Orolia or any of our Approved Service Agents. You can find your nearest Approved Service Agent via our website:

<https://www.oroiamaritime.com/support/mcmurdo/where-to-buy/>



# Orolia Ltd

Silver Point  
Airport Service Road  
Portsmouth PO3 5PB  
United Kingdom

Phone: +44 (0)23 9262 3900  
Fax: +44 (0)23 9262 3998

Email: [customer.service@orolia.com](mailto:customer.service@orolia.com)  
Website: <https://www.oroliamaritime.com>

**23-040-EN Issue C00**

**An Orolia Group Business**