



# Smartfind **M5**

## AIS CLASS A

### USER MANUAL



Smartfind M5 Class A / Inland AIS  
Installation and Maintenance Manual

# General Information

## i. Disclaimer

The information and illustrations contained in this publication are to the best of our knowledge correct at the time of going to print. We reserve the right to change specifications, equipment, installation and maintenance instructions without notice as part of our policy of continuous product development and improvement. No part of this publication may be reproduced, stored in a retrieval system or transmitted in any form, electronic or otherwise without permission in writing from Netwave Systems B.V. No liability can be accepted for any inaccuracies or omissions in the publication, although every care has been taken to make it as complete and accurate as possible.

This manual is applicable for McMurdo Smartfind M5 manufactured after August 2021.

## ii. Safety Warning



It is important to know that AIS is designed for the purpose of anti-collision and serves as a complement to navigation. It is not the absolute navigational equipment and does not replace any navigational system installed on board. Any AIS device cannot guarantee monitoring and receiving signals from all vessels in the surroundings unless those vessels are equipped with AIS devices.



The coastline map in this transponder is neither verified nor approved by Hydrographic Authorities. It is not an Electronic Chart System and therefore should not be used for navigation. The information provided by the coastline map is for reference only and should be used together with other navigation sources and devices.



### **ELECTRICAL SHOCK HAZARD**

Improper disassembly or modification could cause electrical shocks, fire, or personal injury. Contains no user-serviceable parts.



### **RADIO FREQUENCY RADIATION HAZARD**

The AIS transponder emits low levels of radio frequency radiation and has a Maximum Permissible Exposure (MPE) radius of 1.9 m assuming the maximum power of the AIS transponder and an antenna with a maximum gain of 2.9 dBi. The MPE radius has been determined in accordance with FCC OET Bulletin 65. Failure to observe these limits may allow personnel within the MPE radius to be exposed to RF radiation that exceeds the FCC MPE limit. It is the operator's responsibility to ensure that no personnel come within the MPE radius of the antenna.



### **CORRECT POWER SOURCE**

An incorrect power source will damage the equipment and may even result in a fire. Ensure that the correct power source is provided at all times.



### **AVOID DIRECT CONTACT WITH RAIN OR SPLASHING WATER**

Electrical shock or fire could be resulted if water leaks into the equipment.



### **AVOID USING CHEMICAL SOLVENTS TO CLEAN THE CASE**

As some solvents can damage the case material.



### **RADIO LICENCE**

The AIS transponder is a maritime radio transmitter. Some administrations may require that the user holds a valid radio licence to cover its ownership and use.



## NOTE/INFORMATION

Throughout this manual this symbol indicates important information.

### iii. **Product Category**

This product is categorized as “protected” in accordance with the requirements as defined in IEC 60945.

### iv. **Compass Safe Distance**

Safe distance to the transponder (and junction box) unit is:

**Standard-magnetic-compass: 0.50 m**

**Steering-magnetic-compass: 0.40 m**

### v. **Hardware / Software Version**

The model name/number, hardware information, and firmware (software) version of the transponder can be identified through MKD at MENU/DIAGNOSTICS/VERSION. The software maintenance/upgrade of the transponder can be carried out on board via USB interface. The on-board documentation as described in Appendix C can be used to assist reflecting software maintenance records.

### vi. **Type Approval**

The McMurdo Smartfind M5 AIS transponder complies with applicable international standards and is type approved in accordance with the European Marine Equipment Directive.

### vii. **FCC Statement**

This device complies with the GMDSS provisions of part 80 of the FCC rules. The FCC ID for the device is WZ7AIS-A701

### viii. **Declaration of Conformity**

Hereby Netwave Systems B.V. declares that the Type Z601 (McMurdo Smartfind M5) is in compliance with the essential requirements and other relevant provisions of the Marine Equipment Directive (MED) 2014/90/EU. A copy of the Declaration of Conformity can be obtained on-line from: <https://www.seasofsolutions.com/products/mcmurdo-smartfind-m5-ais-class-a-transponder/>

### ix. **Disposal Instruction**

The Waste Electrical and Electronic Equipment (WEEE) Directive aims to minimise any adverse impact of electronic equipment on the environment, both during the product lifetime and when it becomes waste. Within the European Union this legislation is mandated by Directive 2002/96/EC, and there is similar legislation in most other continents. The directive applies to all electronic products such as IT, household appliances, portable electronics etc., and imposes requirements to collect, treat, recover and recycle each product at its end of life. Electronic end-user products must also carry a WEEE label (as below) and recovery and recycling information has to be provided to the recycler.



### x. **IMO Green Passport Ship Recycling Information**

Netwave Systems B.V. hereby declares potentially hazardous content in some of its electronic products. Small amounts of the following substances may be present: beryllium oxide, lithium, lead, brominated flame retardants, glass. In keeping with European directive 2002/96/EC (Waste Electrical and Electrical Equipment) and the provisions of IMO Resolution A.962(23) (Guidelines On Ship Recycling), Netwave Systems B.V. strongly

recommends that its products, including any battery packs, be disposed of in a considerate and legal manner.

**xi. Maintenance**

All servicing must be carried out by an Netwave Systems B.V. approved service agent. Always call your nearest agent and talk to their service department before returning equipment. You can find your nearest service agent from:

- The McMurdo web site: [www.seasofsolutions.com/](http://www.seasofsolutions.com/)
- You can also send an email to [customer.service@seasofsolutions.com](mailto:customer.service@seasofsolutions.com) and someone will be in touch to answer your service and support questions.
- Or contact our offices:  
Netwave Systems B.V.  
Blauw-roodlaan 100,  
2718 SJ Zoetermeer, Netherlands  
Phone: +31 (0) 8811 81500

# Table of Contents

<b>1</b>	<b>WHAT IS AIS?</b> .....	<b>11</b>
<b>2</b>	<b>SYSTEM OVERVIEW</b> .....	<b>12</b>
2.1	PRODUCT DESCRIPTION.....	12
2.2	MAIN FEATURES.....	12
2.3	INTERCONNECTION DIAGRAM .....	13
<b>3</b>	<b>INSTALLATION</b> .....	<b>14</b>
3.1	EQUIPMENT IN THE BOX .....	14
3.2	INSTALLATION PROCEDURES.....	14
3.3	RF CABLE REQUIREMENTS.....	15
3.4	VHF ANTENNA INSTALLATION.....	15
3.5	GPS ANTENNA INSTALLATION .....	16
3.6	MOUNTING SMARTFIND M5 .....	16
3.6.1	Mounting Transponder.....	16
3.6.2	Mounting Junction Box .....	18
3.6.3	Mounting Pilot Plug.....	19
3.7	EXTERNAL CONNECTORS (TRANSPONDER MAIN UNIT).....	21
3.8	EXTERNAL CONNECTORS (JUNCTION BOX).....	22
3.9	CONNECTING EXTENSION CABLE .....	25
3.10	CONNECTING TO POWER SUPPLY.....	26
3.11	CONFIGURING SMARTFIND M5 .....	26
3.11.1	Initial Configuration.....	26
<b>4</b>	<b>OPERATION</b> .....	<b>28</b>
4.1	PANEL DESCRIPTION .....	28
4.1.1	Status Bar .....	29
4.1.2	Transmission and Reception Bar .....	30
4.2	DISPLAY MODES.....	31
4.2.1	Target Symbol Descriptions.....	32
4.2.2	Coastal View.....	34
4.2.3	Radar View .....	35
4.2.4	Dimmer Setting.....	35
4.3	ENTERING TEXT.....	36
4.4	MENU TREE OVERVIEW.....	38
4.4.1	How to access and use MAIN MENU.....	39
4.4.2	Menu Item Brief Description .....	40
4.5	MESSAGES.....	42
4.5.1	Inbox SRM .....	42
4.5.2	Outbox SRM .....	43
4.5.3	Broadcast SRM.....	43
4.5.4	Addressed SRM.....	44
4.5.5	Long Range SRM .....	45
4.6	INLAND MESSAGES.....	45
4.6.1	ETA/RTA Inbox.....	46
4.6.2	ETA Outbox .....	46
4.6.3	Create ETA Message .....	46
4.6.4	POB Outbox.....	47
4.6.5	Create POB Message.....	48
4.6.6	EMMA Warning.....	48
4.6.7	Water Level.....	49
4.7	NAVIGATION STATUS .....	49

4.7.1	Own Ship .....	50
4.7.2	AIS Targets .....	51
4.7.3	Region List .....	53
4.7.4	Active Alert .....	54
4.7.5	Active BIIT List .....	56
4.7.6	BIIT History .....	57
4.7.7	Sensor Status .....	57
4.7.8	Dangerous List .....	58
4.7.9	MOB List .....	59
4.7.10	Friend Ships .....	59
<b>4.8</b>	<b>SHIP SETTING .....</b>	<b>60</b>
4.8.1	Own Ship .....	60
4.8.2	Voyage .....	61
4.8.3	CPA/TCPA .....	62
4.8.4	Extended Tow Dimension Values .....	62
4.8.5	SET MMSI/IMO/ENI .....	63
4.8.6	Retry Times .....	64
4.8.7	AIS Mode .....	64
<b>4.9</b>	<b>INLAND SETTING .....</b>	<b>64</b>
4.9.1	Vessel Data Setting .....	66
4.9.2	ETA Setting .....	66
4.9.3	Number of Person .....	67
4.9.4	Blue Sign Setting .....	67
4.9.5	Report Rate Setting .....	67
<b>4.10</b>	<b>TRANSCEIVER .....</b>	<b>68</b>
<b>4.11</b>	<b>SYS CONFIG .....</b>	<b>68</b>
4.11.1	Customize .....	69
4.11.2	Radar View .....	69
4.11.3	Map Calibration .....	70
4.11.4	Sensor Config .....	70
4.11.5	Factory .....	71
4.11.6	Password .....	71
4.11.7	Long Range Setting .....	72
4.11.8	Long Range Broadcast .....	72
4.11.9	Destination Table Setting .....	73
4.11.10	Alarms Setting .....	73
4.11.11	VSWR Setting .....	74
<b>4.12</b>	<b>DIAGNOSTICS .....</b>	<b>75</b>
<b>5</b>	<b>TECHNICAL SPECIFICATIONS .....</b>	<b>78</b>
5.1	APPLICABLE STANDARDS .....	78
5.2	VHF TRANSCEIVER .....	78
5.3	DSC RECEIVER .....	78
5.4	GPS RECEIVER (INTERNAL) .....	79
5.5	POWER SUPPLY .....	79
5.6	LCD DISPLAY .....	79
5.7	KEYPAD & KNOB .....	79
5.8	CONNECTION INTERFACE .....	79
5.9	ENVIRONMENTAL .....	80
5.10	PHYSICAL .....	80
5.11	PILOT PLUG .....	80
5.12	NMEA 2000 PGN INFORMATION .....	81
<b>6</b>	<b>MECHANICAL DIMENSIONS .....</b>	<b>82</b>



6.1	SMARTFIND M5 TRANSPONDER MAIN UNIT.....	82
6.2	JUNCTION BOX.....	84
6.3	EXTENSION CABLE.....	84
6.4	MOUNTING TEMPLATE (NOT TO SCALE).....	84
6.5	GPS ANTENNA.....	85
6.6	PILOT PLUG.....	85
7	TROUBLESHOOTING.....	86
8	ABBREVIATIONS.....	87
9	WARRANTY STATEMENT.....	89
APPENDIX (A).....		90
A.1.1	SENSOR DATA INPUT PORTS.....	90
A.1.2	BIDIRECTIONAL DATA PORTS.....	91
A.1.3	A AND B SIGNAL LINES.....	91
A.1.4	OUTPUT DRIVER.....	91
A.1.5	INPUT LOAD.....	91
A.1.6	HARDWARE INPUT/OUTPUT CIRCUIT.....	91
A.5.1	ABM – AIS ADDRESSED BINARY AND SAFETY RELATED MESSAGE.....	94
A.5.2	ACA – AIS CHANNEL ASSIGNMENT MESSAGE.....	94
A.5.3	ACK – ACKNOWLEDGE ALARM.....	95
A.5.4	AIQ - QUERY SENTENCE.....	95
A.5.5	AIR – AIS INTERROGATION REQUEST.....	95
A.5.6	BBM – AIS BROADCAST BINARY MESSAGE.....	96
A.5.7	DTM – DATUM REFERENCE.....	96
A.5.8	EPV – COMMAND OR REPORT EQUIPMENT PROPERTY VALUE.....	96
A.5.9	GBS – GNSS SATELLITE FAULT DETECTION.....	97
A.5.10	GGA – GLOBAL POSITIONING SYSTEM (GPS) FIX DATA.....	97
A.5.11	GLL – GEOGRAPHIC POSITION – LATITUDE/LONGITUDE.....	97
A.5.12	GNS – GNSS FIX DATA.....	98
A.5.13	GSA – GNSS DOP AND ACTIVE SATELLITES.....	98
A.5.14	HDG – HEADING, DEVIATION AND VARIATION.....	99
A.5.15	HDT – HEADING TRUE.....	99
A.5.16	LRF – AIS LONG-RANGE FUNCTION.....	99
A.5.17	LRI – AIS LONG-RANGE INTERROGATION.....	99
A.5.18	OSD – OWN SHIP DATA.....	100
A.5.19	RMC – RECOMMENDED MINIMUM SPECIFIC GNSS DATA.....	100
A.5.20	ROT – RATE OF TURN.....	100
A.5.21	SPW - SECURITY PASSWORD SENTENCE.....	101
A.5.22	SSD – AIS SHIP STATIC DATA.....	101
A.5.23	THS – TRUE HEADING AND STATUS.....	101
A.5.24	VBW – DUAL GROUND/WATER SPEED.....	101
A.5.25	VHW – WATER SPEED AND HEADING.....	102
A.5.26	VSD – AIS VOYAGE STATIC DATA.....	102
A.5.27	VTG – COURSE OVER GROUND AND GROUND SPEED.....	102
A.5.28	PAMC, DBG – PROPRIETARY SENTENCES, DEBUG.....	103
A.5.29	PAMC, DSC – PROPRIETARY SENTENCES, DIGITAL SELECTIVE CALLING.....	103
A.6.1	ABK – AIS ADDRESSED AND BINARY BROADCAST ACKNOWLEDGEMENT.....	104
A.6.2	ACA – AIS CHANNEL ASSIGNMENT MESSAGE.....	104
A.6.3	ALR – SET ALARM STATE.....	105
A.6.4	EPV – COMMAND OR REPORT EQUIPMENT PROPERTY VALUE.....	105
A.6.5	LR1 – AIS LONG-RANGE REPLY SENTENCE 1.....	105
A.6.6	LR2 – AIS LONG-RANGE REPLY SENTENCE 2.....	106

A.6.7 LR3 – AIS LONG-RANGE REPLY SENTENCE 3.....	106
A.6.8 LRF – AIS LONG-RANGE FUNCTION .....	106
A.6.9 TXT – TEXT TRANSMISSION .....	107
A.6.10 VDM – AIS VHF DATA-LINK MESSAGE .....	107
A.6.11 VDO – AIS VHF DATA-LINK OWN-VESSEL REPORT .....	107
<b>APPENDIX (B).....</b>	<b>108</b>
B.1 MONITORING OF SYSTEM FUNCTIONS AND INTEGRITY.....	108
B.2 ANTENNA VSWR EXCEEDS LIMIT .....	108
B.3 DETECTION OF TX MALFUNCTION .....	108
B.4 DETECTION OF RX MALFUNCTION.....	108
<b>APPENDIX (C).....</b>	<b>109</b>
INSTALLATION AND MAINTENANCE RECORD.....	109
SOFTWARE REVISIONS.....	111
<b>APPENDIX (D).....</b>	<b>112</b>
USCG AIS INSPECTION CHECKLIST & REPORT .....	112

# 1 WHAT IS AIS?

---

The Automatic Identification System (AIS) is a Very High Frequency (VHF) radio broadcasting system that transfers packets of data over the VHF data link (VDL) and enables AIS equipped vessels and shore-based stations to exchange identification information and navigational data. Ships with AIS transponders continually transmit their ID, position, course, speed and other data to all nearby ships and shore stations. Such information can aid greatly in situational awareness and provide a means to assist in collision avoidance.

AIS equipment is standardized by ITU, IEC, IALA and IMO and is subject to approval by a certification body. The following AIS devices have been developed for variant applications.

- **AIS Class A:**  
mandated by the IMO for vessels of 300 gross tonnages and upwards engaged on international voyages, cargo ships of 500 gross tonnages and upwards, as well as passenger ships. It transmits typically on 12.5 watt output power.
- **Inland AIS:**  
all the features of a Class A transceiver with the addition of features required for Inland waterways.
- **AIS Class B:**  
provides limited functionality and is intended for non-SOLAS commercial vessels and recreational vessels. It transmits typically on 2 watt output power.
- **AIS Base Station:**  
is provided by aids-to-navigation authorities to enable the ship to shore / shore to ship transmission of information. Networked AIS Base Stations can assist in providing overall maritime domain awareness.
- **AIS AtoN (Aids to Navigation):**  
provides an opportunity to transmit position and status of buoys and lights through the same VDL, which can then show up on AIS-ready devices within the range.
- **AIS SART:**  
Search and Rescue Transmitter using AIS can be used to assist in determining the location of a vessel in distress. It is typically used on life rafts.
- **AIS on Search and Rescue (SAR) Aircraft:**  
used on airplanes and helicopters to assist search and rescue operation.

## 2 SYSTEM OVERVIEW

---

### 2.1 Product Description

The McMurdo Smartfind M5 is a new generation AIS Class A transponder fully compliance with IMO, IEC, and ITU international standards. It provides a compact single box solution, easy to install and operate. The unit is designed with advanced technology which sets a new standard for quality, performance, and value. It is an excellent choice for SOLAS vessels, commercial vessels, and professional vessels.

The Smartfind M5 consists of a transceiver radio unit, an integrated GPS receiver, a controller unit, and a colour 3.5" LCD display with menu keypads. The radio has three receivers -- two TDMA receivers and one DSC receiver. The transmitter alternates its transmission between the two operating TDMA. The controller unit creates and schedules data packets (containing dynamic, static and voyage related data) for transmission based on the IMO performance standard for AIS.

The Smartfind M5 can be connected to the ship's sensors as required by the IALA guidelines through an external junction box (supplied in the package). The unit can also interface external navigation and presentation systems that support IEC 61162-1 related sentences. It is also capable for connection to Long Range system like Inmarsat C. The Smartfind M5 supports both IMO and Inland AIS which is configurable by the software.

The colour LCD display and menu keypads provide an intuitive graphical user-friendly interface to the system. It can display the location of other vessels, aids to navigation and search and rescue vessels. The AIS transmit and receive status are shown on the screen which helps user to know the working status of the unit easily. The LCD and keypad can also be used to send and receive messages, perform configuration as well as supervise the systems status.



### 2.2 Main Features

- Compact AIS Class A solution, easy to install and operate
- Fully compliant with IMO, IEC, and ITU international standards
- Colour 3.5" LCD display with variant display modes
- User-friendly intuitive GUI & keypad operation
- Knob dial, click and push, for simple operation
- IMO/Inland AIS mode selectable
- Multiple sensor input ports and bi-directional data ports
- USB (device only) and NMEA2000 connectivity ready
- Support type P of BAM function type

## 2.3 Interconnection Diagram

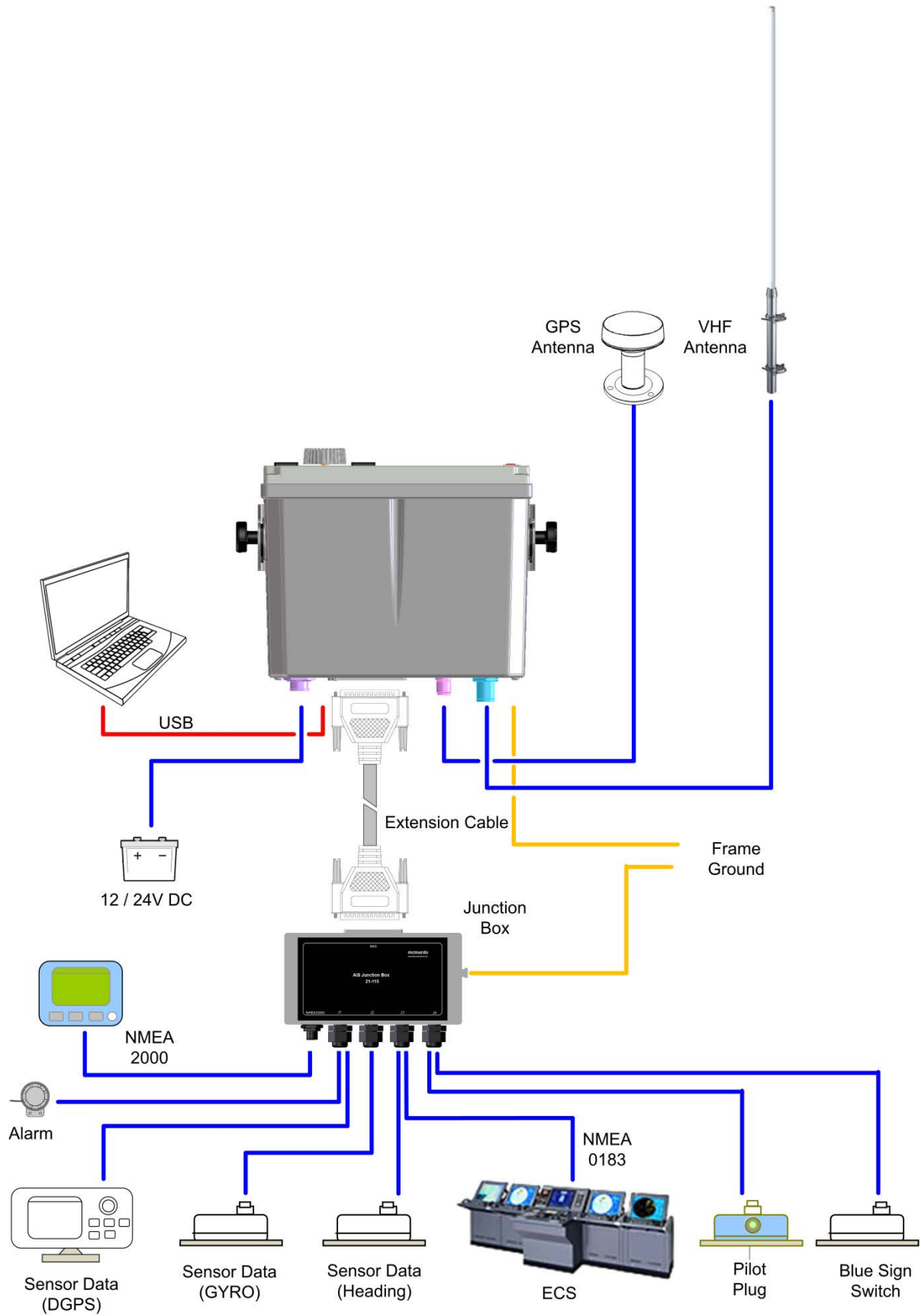

Figure 1 Interconnection Diagram

## 3 INSTALLATION

### 3.1 Equipment in the Box

The standard supply in the package includes the following items. Please contact your local representative if any item is missing.

Description	Quantity
Smartfind M5 Class A AIS Transponder	1
Ships cable junction box	1
U-shaped mounting bracket	1
Knobs for u-shaped mounting brackets	2
37-pin extension cable 1.8 m	1
3-pin power cable 1m	1
USB to Mini-USB data cable 1.8 m	1
Panel mount stainless bracket kit with screws	2
M3.5X10 screws for u-shaped mounting bracket	5
M3X8 screws for panel mount brackets	6
Panel mount cutting template	1
Screw, wall-plug, mounting stand for junction box	4
Installation and operation manual	1
Software CD	1
GPS antenna with integrated cable 10m	1
GPS antenna mounting bracket kit	1
Pilot plug box with wired cable 2m	1
Screws for pilot plug box	2

### 3.2 Installation Procedures

Please familiarize the manual content before beginning installation. Use the following recommended steps for installation.

1. Mount the transponder unit in a desired location
2. Mount junction box.
3. Install VHF antenna (not supplied)
4. Install GPS antenna
5. Connect all external sensors and data interfaces to the junction box
6. Connect all required cables to the main transponder unit
7. Power on the main transponder unit
8. Complete configuration settings
9. Perform system functional test

### 3.3 RF Cable Requirements

The following RF cables are recommended to install the Smartfind M5.

- **VHF Antenna Cable**

Type: 5D-FB or RG214 or equivalent  
Connector: PL-259 (Male)

- **GPS Antenna Cable**

Type: RG58A/U or equivalent  
Connector: TNC (Male)  
Cable and connector are supplied as part of the GPS antenna.

### 3.4 VHF Antenna Installation

The quality and positioning of the antenna are the most important factors dictating AIS performance. It is recommended that a VHF antenna with omni directional vertical polarization be specifically tuned for AIS operation band. Since the range of VHF signals is largely decided by line of sight distance, the VHF antenna should be placed as high as possible and at least 5 meters away from any constructions made of conductive materials.

To avoid interference, the VHF antenna location should be placed accordingly as diagram below:

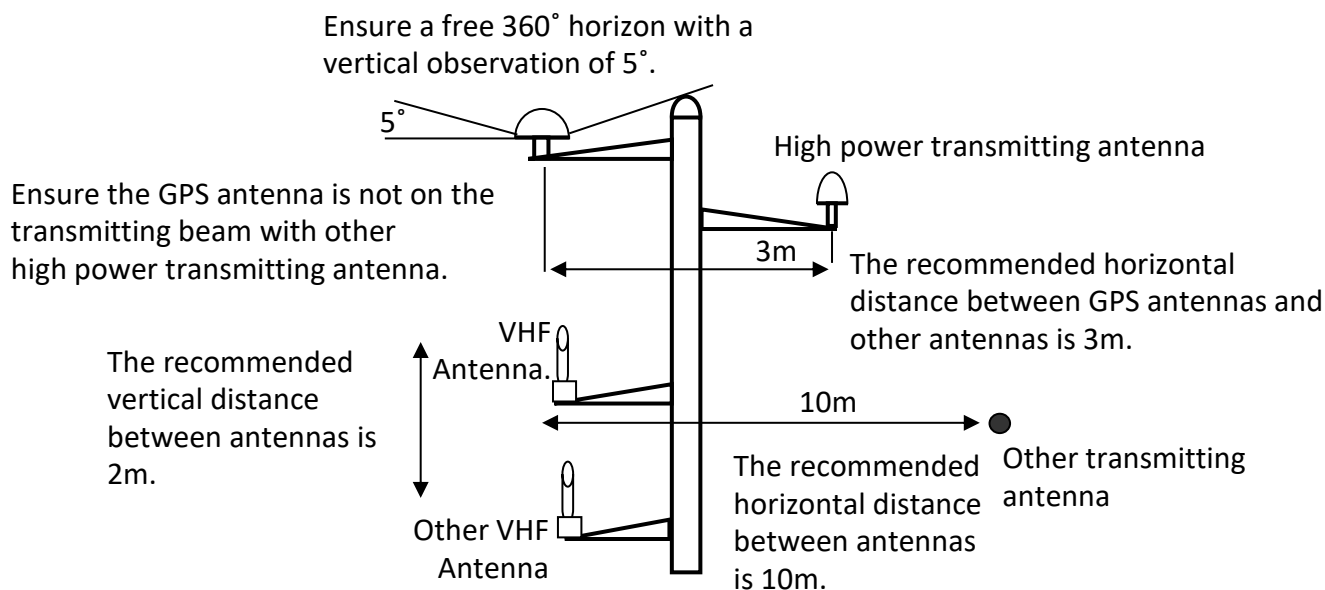

**Figure 2 VHF/GPS Antenna Locations**

### 3.5 GPS Antenna Installation

The GPS antenna must be installed where it has a clear view of the sky, so that it may access the horizon freely with 360° degrees, with a vertical observation of 5 to 90 degrees above the horizon as illustrated above.

#### GPS ANTENNA LOCATION

Note the GPS antenna location with reference to the ships plan view in meters in APPENDIX (C).

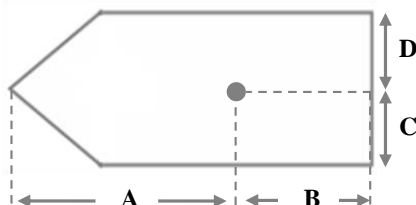

Figure 3 GPS Antenna location

### 3.6 Mounting Smartfind M5

Use the following guidelines to check the installation location for your AIS transponder:

- The AIS transponder should be mounted in a location that is accessible and readable to user at all time.
- The transponder should be installed in a protected environment away from direct rain and water contact.
- The transponder is designed to operate in an environment with 15°C ~ 55°C temperature. Environments with excessive heat may cause damages to the transponder.
- The transponder should not be installed near flammable or hazardous environments.
- The AIS transponder should be installed at least 0.5m away from magnetic compasses.

#### 3.6.1 Mounting Transponder

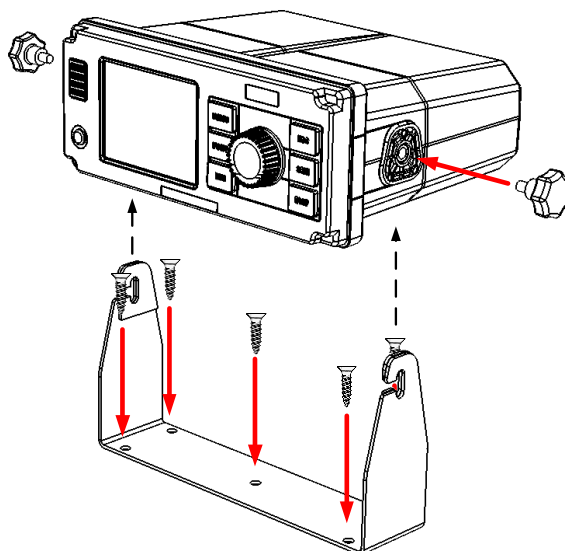
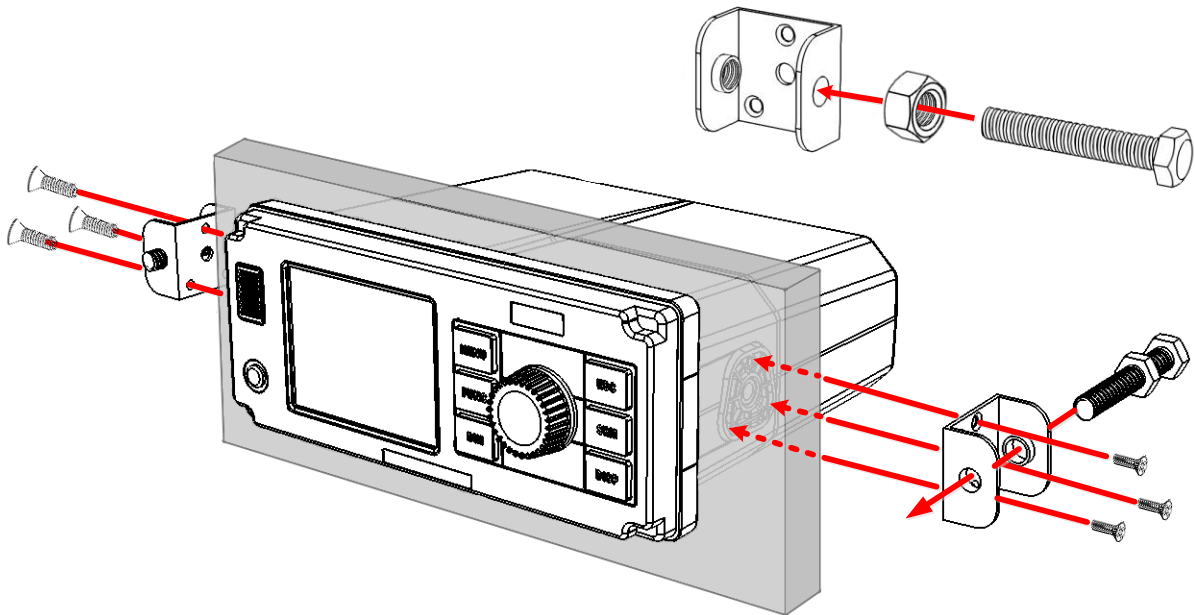

Figure 4 Mounting Smartfind M5



## **Panel Mounting (1)**

1. Line up the mounting template on control panel to sketch an outline for the cutting area.
2. Using a jigsaw carefully cut along the sketched cutting area.
3. If necessary, clean up edge with glass paper or file.
4. Mount the transponder through the opening.
5. From the rear, install the mounting brackets with the M3X8 screws.
6. Apply the mounting bracket screw (brackets are directional ensure correct one is fitted to each side) on each side for a firm fix.



**Figure 5 Panel Mounting (1)**

## **Panel Mounting (2)**

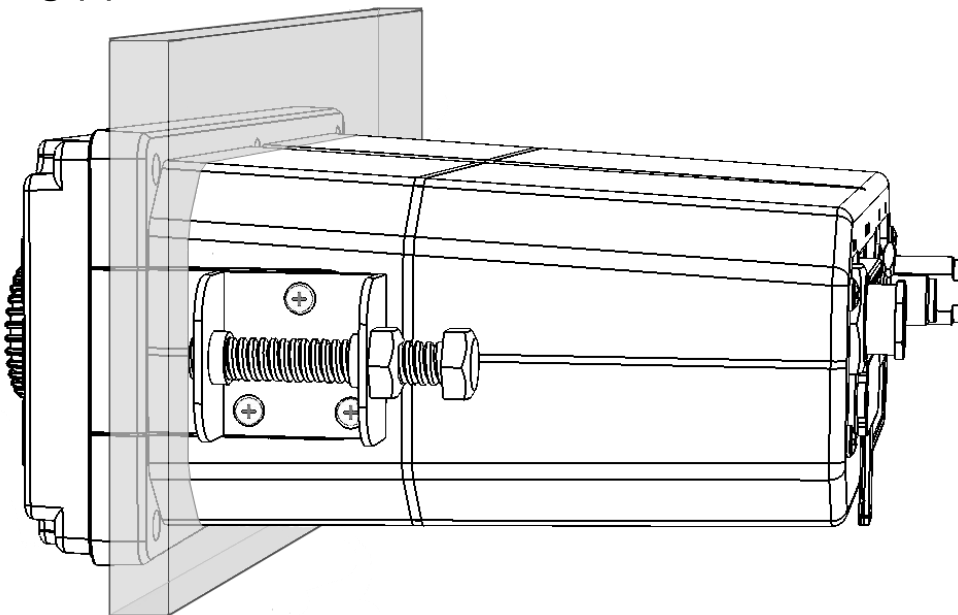

**Figure 6 Panel Mounting (2)**

### 3.6.2 Mounting Junction Box

#### Mounting Junction Box (1)

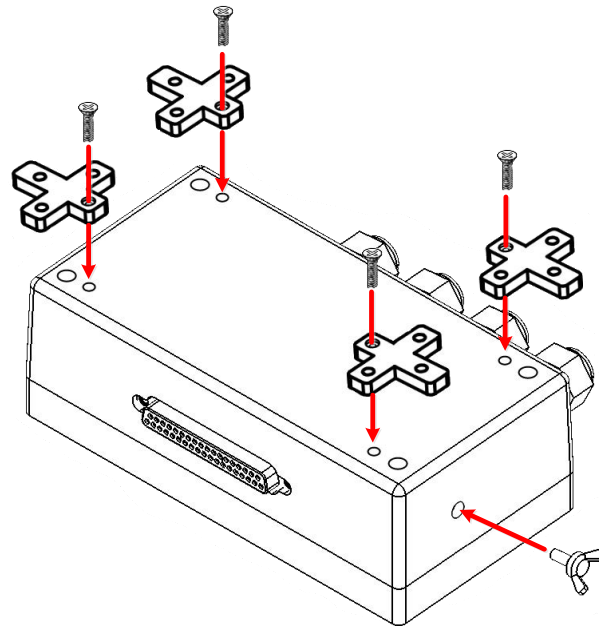

Figure 7 Mounting Junction Box (1)

#### Mounting Junction Box (2)

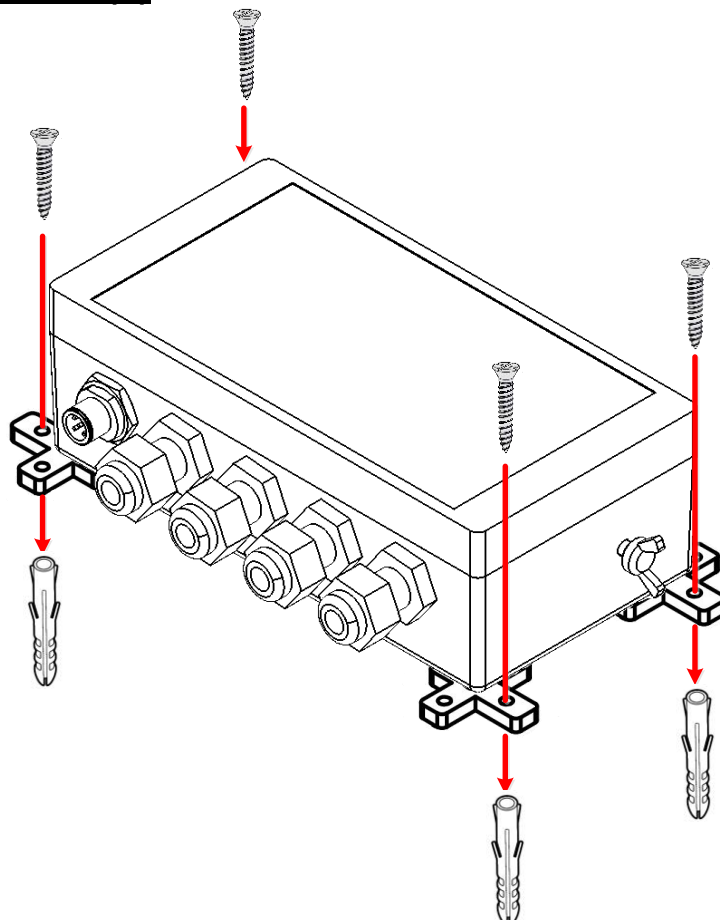
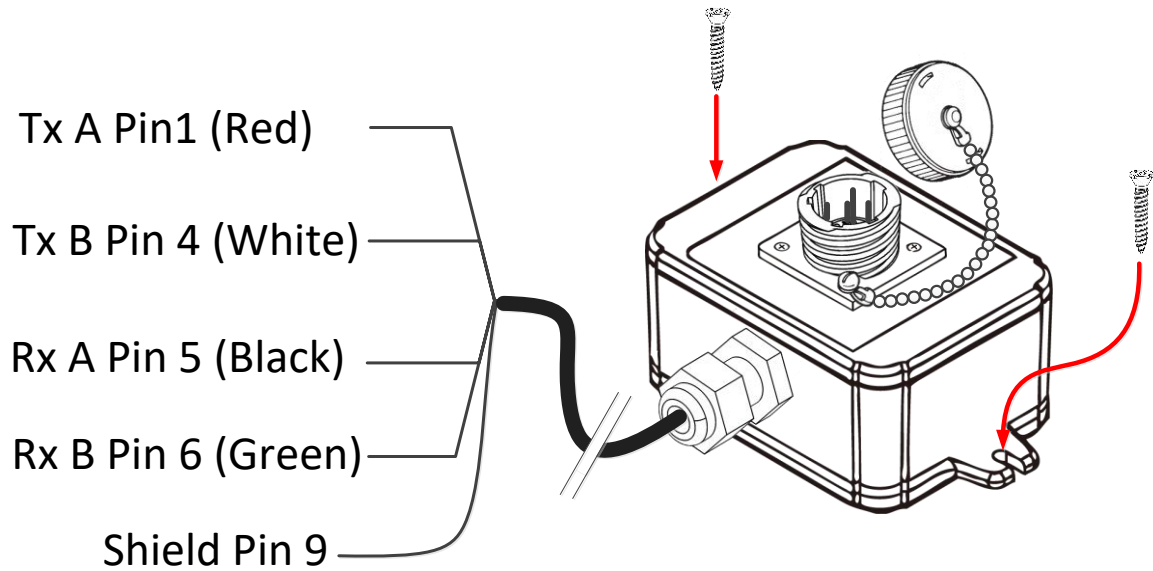

Figure 8 Mounting Junction Box (2)

### 3.6.3 Mounting Pilot Plug

The Pilot Plug device provides connecting interface to pilots and other mariners to connect their own PC or other portable device to the transponder on board.

#### Smartfind M5 Pilot Plug



Pin Number	Function	Wire Colour
Pin 1	Tx A	Red
Pin 2	--	
Pin 3	--	
Pin 4	Tx B	White
Pin 5	Rx A	Black
Pin 6	Rx B	Green
Pin 7	--	
Pin 8	--	
Pin 9	Shield (Ground)	

## Connecting to the Junction Box

Use the following guidelines to connect the Pilot Plug to the Junction box.  
Please refer to section 3.8 External Connectors (Junction Box).

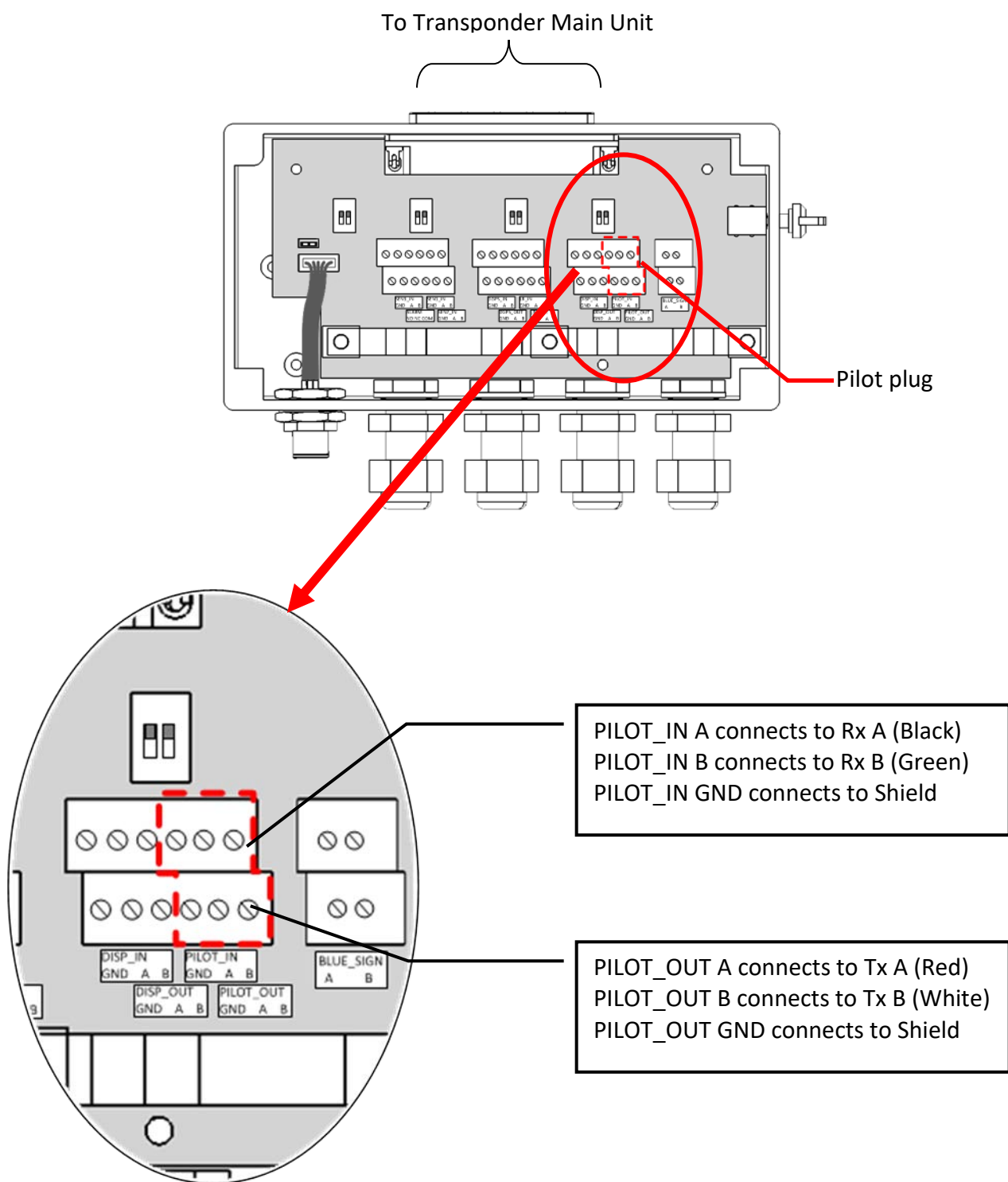

**Note:** Shield can connect to either PILOT\_IN GND or PILOT\_OUT GND.

### 3.7 External Connectors (Transponder Main Unit)

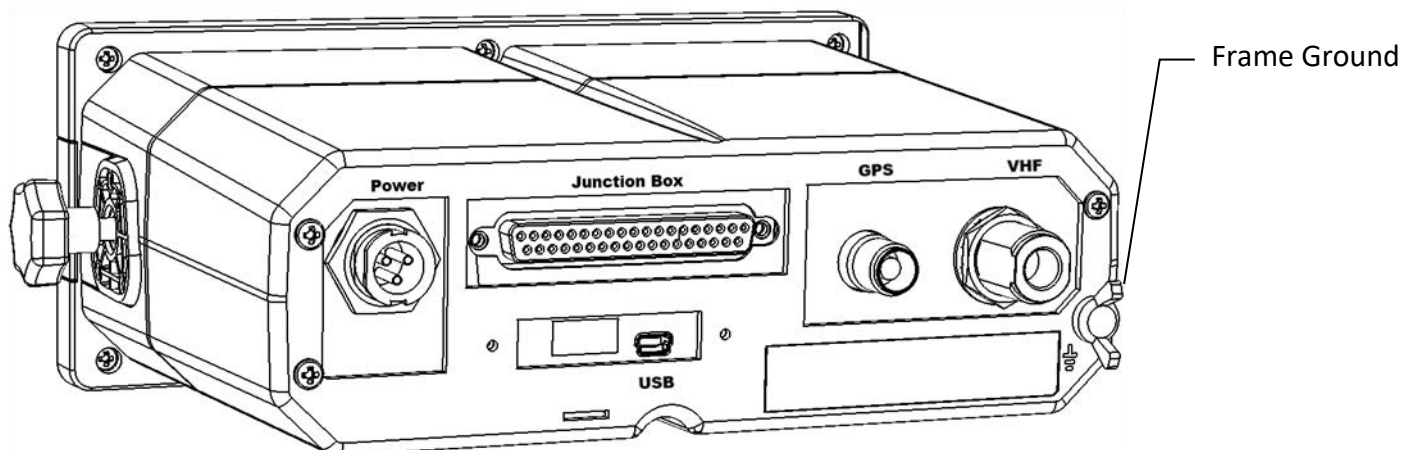

**Figure 9 External Connectors (Main Unit)**

NAME	DESCRIPTION	TYPE OF CONNECTOR
<b>VHF</b>	VHF antenna connector	SO-239 (female)
<b>GPS</b>	GPS antenna connector	TNC (female)
<b>Power</b>	Power input connector	Round type, 3 pins. Cable Supplied Red Wire – Power 12/24V Black Wire - Power Ground White Wire - Not used
<b>USB</b>	USB connection to PC	Mini type USB
<b>Junction Box</b>	Extension connection to Junction Box	D-Sub 37 pins
<b>Frame Ground</b>	Connect to ship frame	

**Note:** Some boats require frame ground connection of all electronic devices on the ship frame.

#### Vessel Power supply requirement

Connect to the ship's 12-24 V DC emergency power source. Ideally this should be an uninterrupted power supply (UPS), through a 2-pole switched fused supply to allow isolation for servicing.

Power requirement 12 - 24 V DC typical 5 A minimum.

Required conductor area, cable length 0-10m is 1.5 mm<sup>2</sup> minimum

**Note.** The Class A (M5) Power supply requirement should comply with IMO guidelines for the class of vessel concerned. National authorities and classification societies may have their own power supply requirements; these should also be considered.

### 3.8 External Connectors (Junction Box)

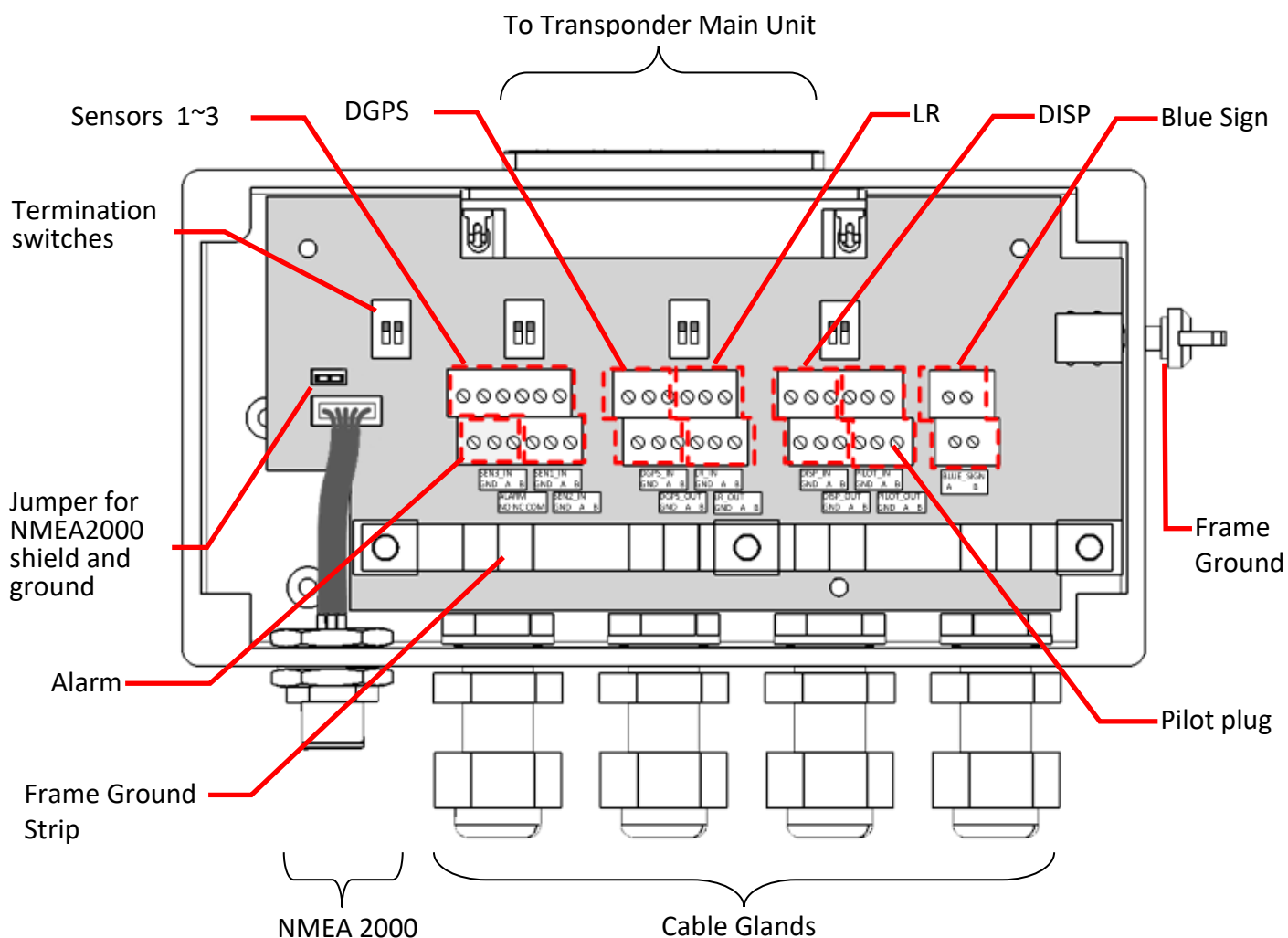

**Figure 10 External Connectors (Junction Box)**

CONNECTOR	LABEL NAME	DESCRIPTION	FUNCTION USAGE
<b>Sensor 1</b>	SEN1_IN GND	Sensor 1 ground	Connect to data sources such as heading, gyro, or other type of sensors.
	SEN1_IN A	Sensor 1 input A	
	SEN1_IN B	Sensor 1 input B	
<b>Sensor 2</b>	SEN2_IN GND	Sensor 2 ground	Connect to data sources such as heading, gyro, or other type of sensors.
	SEN2_IN A	Sensor 2 input A	
	SEN2_IN B	Sensor 2 input B	
<b>Sensor 3</b>	SEN3_IN GND	Sensor 3 ground	Connect to data sources such as heading, gyro, or other type of sensors.
	SEN3_IN A	Sensor 3 input A	
	SEN3_IN B	Sensor 3 input B	

<b>Pilot Plug</b>	PILOT_IN GND	Input Ground	Pilot Plug port
	PILOT_IN A	Input A	
	PILOT_IN B	Input B	
	PILOT_OUT GND	Output Ground	
	PILOT_OUT A	Output A	
	PILOT_OUT B	Output B	
<b>Alarm</b>	ALARM NO	Alarm normally open	When wiring external alarm unit use N/C and Common terminals to drive alarm. Alarm will sound until alarm messages are acknowledged as read in Alarm list
	ALARM NC	Alarm normally closed	
	ALARM COM	Alarm common	
<b>DGPS Input</b>	DGPS_IN GND	DGPS input ground	DGPS sensor
	DGPS_IN A	DGPS input A	
	DGPS_IN B	DGPS input B	
<b>DGPS Output</b>	DGPS_OUT GND	DGPS output ground	DGPS sensor
	DGPS_OUT A	DGPS output A	
	DGPS_OUT B	DGPS output B	
<b>LR Input</b>	LR_IN GND	LR input ground	Long range input
	LR_IN A	LR input A	
	LR_IN B	LR input B	
<b>LR Output</b>	LR_OUT GND	LR output ground	Long range output
	LR_OUT A	LR output A	
	LR_OUT B	LR output B	
<b>Display</b>	DISP_IN GND	DISP input ground	Connect to the data output of an external display system such as ECDIS.
	DISP_IN A	DISP input A	
	DISP_IN B	DISP input B	
	DISP_OUT GND	DISP output ground	Connect to the data input of an external display system such as ECDIS.
	DISP_OUT A	DISP output A	
	DISP_OUT B	DISP output B	
<b>Blue Sign</b>	BLUE_SIGN A		Connect to a blue sign switch.
	BLUE_SIGN B		

**NOTICE:**

1. RTCM-SC-104 beacon input is currently not implemented by the DGPS\_IN input.
2. Suitable electric wire gauge (single wire) for installing Junction Box: AWG 26 ~ 16. See diagram below.



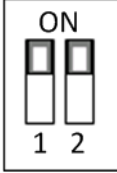

ITEM	USAGE
<p style="text-align: center;"><b>Termination Switches</b></p>	<p>The switches provide line termination configuration.</p> <div style="border: 1px solid black; padding: 10px; margin: 10px auto; width: fit-content;"> <p style="display: flex; justify-content: space-around;"> <span>Termination off</span> <span>Termination on</span> </p> <div style="display: flex; justify-content: space-around; align-items: center;"> <div style="text-align: center;"> <p>ON</p>  <p>1 2</p> </div> <div style="text-align: center;"> <p>ON</p>  <p>1 2</p> </div> </div> </div>
<p><b>Jumper for NMEA2000 shield and ground</b></p>	<p>The jumper's purpose is to wire together NMEA2000 cable's shield and ground. Depending on your scenario, you may choose not to connect them together.</p>

### 3.9 Connecting Extension Cable

Use the 37-pin- extension cable (1.8M) provided in the package connect Smartfind M5 to the junction box.

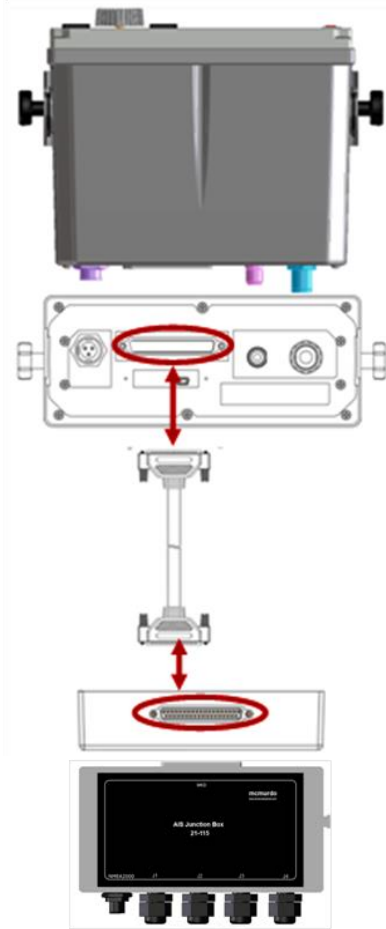

**Figure 11 Connecting Smartfind M5 with Junction Box**

### 3.10 Connecting to Power Supply

The Smartfind M5 requires a 12V or 24V DC power supply (9.6 to 31.2V operation range) capable of supplying 8A peak current. The red wire and the black wire on the 3 pin cable are used to connect the power supply's positive and negative terminals. A 10 Amp fuse or circuit breaker must be used in the connection between the power supply and the unit.

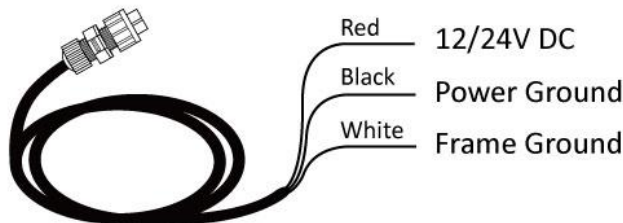

Figure 12 M5 Power Connection

### 3.11 Configuring Smartfind M5

The following items must be completed before initial configuration.

1. Ensure VHF and GPS antennas are connected to the transponder main unit.
2. Ensure the 37-pin-connector extension cable is connected from the transponder main unit to the junction box.
3. Ensure the power cable is connected and supplied with stable voltage/current power source.
4. Ensure applicable external devices are connected through the junction box.

#### 3.11.1 Initial Configuration

The initial configuration, particular, **MMSI** (Maritime Mobile Service Identity) number must be done before operation. The following initial configuration is required:

1. Step 1: **MMSI** should be correctly programmed.

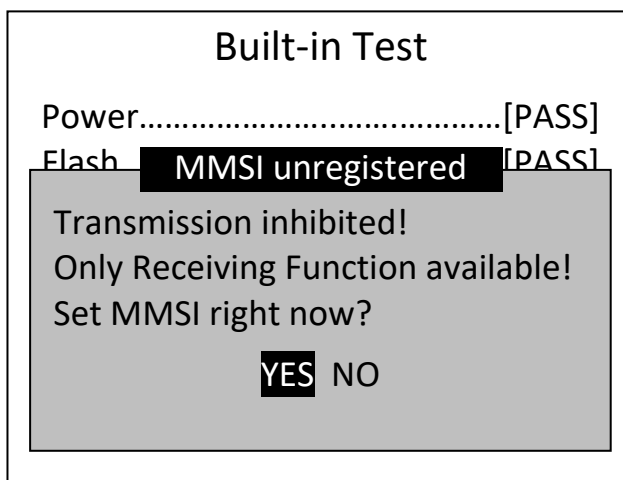

Figure 13 Built-in Test

2. Step 2: Press **MENU** and select main menu item **SHIP SETTING**. (Password required, default

is “0000”)

A. Setup call sign, ship name, ship type, external/internal GPS antenna position in **OWN SHIP**.

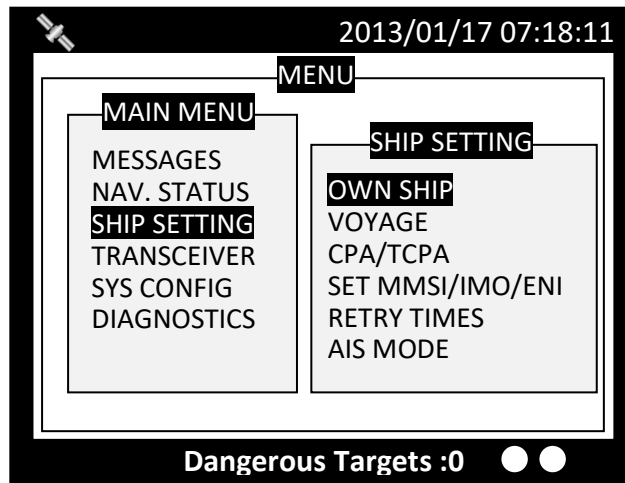

Figure 14 Own Ship

B. If **IMO** identification number is applicable, select main menu item **SET MMSI/IMO/ENI** to setup **IMO** number.

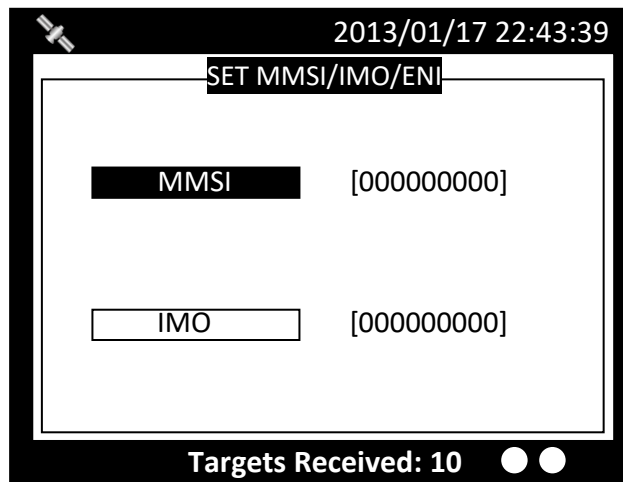

Figure 15 IMO Setting

For more information please refer to **4.8 SHIP SETTING**.

# 4 OPERATION

## 4.1 Panel Description

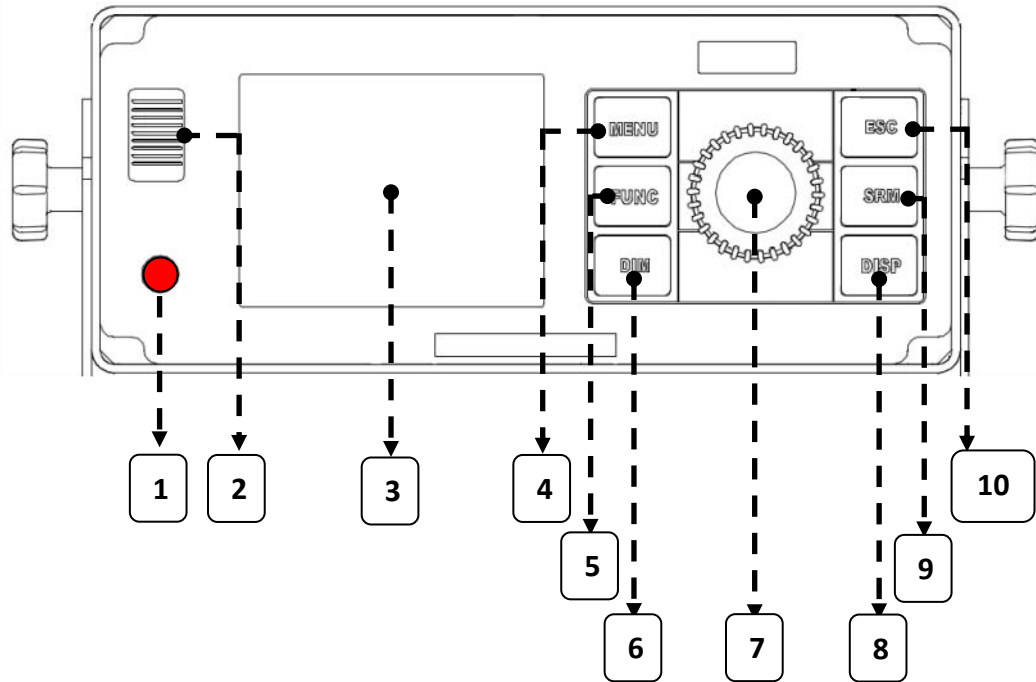
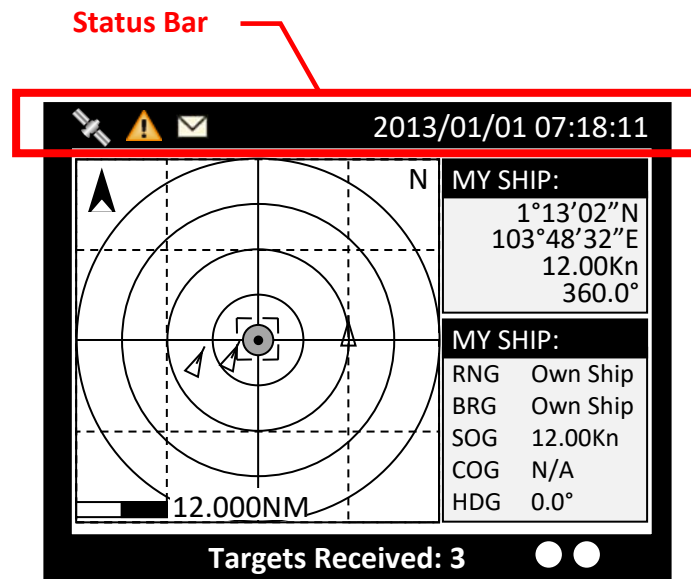

Figure 16 Panel Description

Item Number	Name	Descriptions
1	<b>Power Switch</b>	Power On/Off (push button)
2	<b>Beeper</b>	Sounds when buttons pushed and by MOB Alarm
3	<b>Display</b>	3.5" LCD colour screen
4	<b>MENU</b>	Return to main menu / detail menu select
5	<b>FUNC</b>	Different function on display mode (Zoom In/Out, etc) and has different roles in submenus
6	<b>DIM</b>	Adjust dim degree (refer to 4.2.4)
7	<b>Knob</b>	Rotate to select, press to confirm
8	<b>DISP</b>	Change to different display mode: 1. Coastal View                      5. Own Ship Detail 2. Radar View                         6. GPS satellite information 3. AIS Target List                    7. Region Setting List 4. Dangerous Target list
9	<b>SRM</b>	Broadcast SRM (Safety Related Message)
10	<b>ESC</b>	Cancel / Return to previous menu & Press and hold for 3 seconds to access Alarm List

### 4.1.1 Status Bar

The status bar constantly indicates Date (YYYY/MM/DD), Time, GPS status, ALR, and SRM.



**Figure 17 Status Bar**











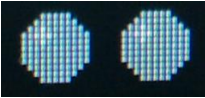

	GPS Status : Position fixed
	GPS Status : Non-fixed
	ALR Status : Alarm messages occurs
	Inbox SRM : Unread coming SRM message
	SART/MOB: SART or MOB message received
	EMMA warning (RFM23) : warning received
	ETA/RTA: message received
	Water levels (RFM24): message received

## 4.1.2 Transmission and Reception Bar

The Transmission & Reception bar constantly displays real time status of transmissions and receptions on any display modes. The 3 default displayed messages are received AIS targets, dangerous targets, and Tx power level.

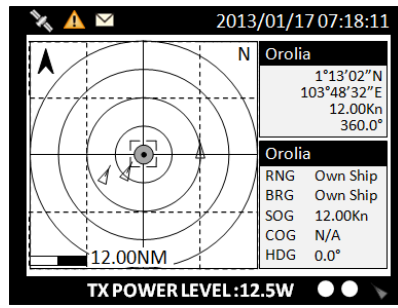
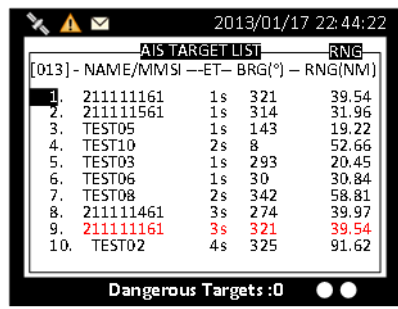
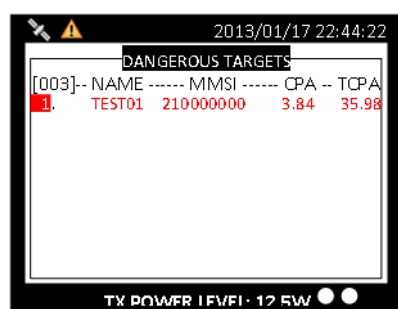
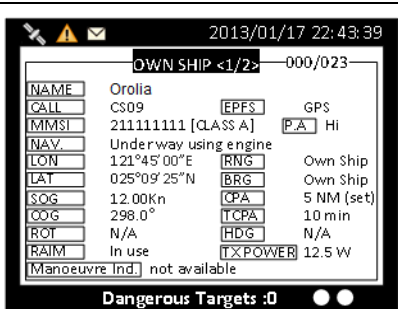

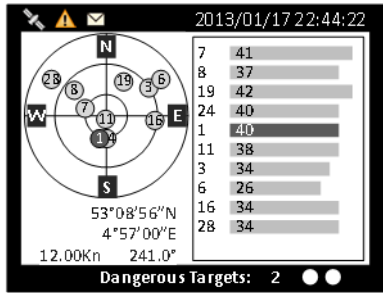

Figure 18 Transmission and Reception Bar

Item Number	Name	Function	
1	<b>Text Banner</b>	Shows the numbers of “Targets Received” and “Dangerous Targets” automatically.	
2	<b>Indicators</b>  Ch.87 Ch.88		No transmissions & receptions: No flash
			Reception of AIS message: Flash green colour
			Transmission of AIS message: Flash red colour
3	<b>Function Icon (Coastal view only)</b>	 Zoom In/Out  Up/Down  Left/Right  Select Target  SART/MOB	The function icon indicates the knob’s action differently in operations. Push <b>FUNC</b> enables the knob to operate different actions  SART/MOB alert icon only available when valid SART or MOB target is received
	<b>Function Icon (Radar view only)</b>	 Zoom In/Out  Select Target  SART/MOB	
4	<b>Inland mode</b>	<b>IL</b>	Indicate the system is running Inland mode
	<b>Blue sign</b>	<b>B</b>	Indicate Blue Sign device is connected

## 4.2 Display Modes







For quick access, users can rotate display modes by simply pressing the **DISP** button.

Display Mode	Screen Shot	Purpose
Coastal View		Display all targets on basic coastline map (Refer to section 4.2.2 Coastal View)
Radar View		Displays all targets on radar view (Refer to section 4.2.3 Radar View)
AIS Target List		Shows all received ship data (Refer to section 4.7.2 AIS Targets)
Dangerous Target List		Shows all dangerous AIS targets presently (Refer to section 4.7.7 Dangerous List)
Own Ship Detail		Shows all the details of own ship (Refer to section 4.7.1 Own Ship Detail)







<p><b>GPS Satellite Information</b></p>		<p>Shows the GPS satellite current usage status (Refer to section 4.12 GPS Status)</p>
<p><b>Region Setting List</b></p>		<p>Show all the Region of own ship (Refer to section 4.7.3 Own Ship Detail)</p>

## 4.2.1 Target Symbol Descriptions

Symbols for each AIS target displayed on the radar view is as described below:

<p><b>Own Ship</b></p> 	<p><b>GPS Reception: Normal / Colour: Black and Grey</b> Under normal GPS reception, own ship is located in the centre of the radar view.</p>
<p><b>Own Ship</b></p> 	<p><b>GPS Reception: No GPS / Colour: Blue</b> Without GPS reception, own ship needs to be located manually.</p>
<p><b>AIS Target</b></p> 	<p><b>Colour: Black</b> Ship equipped with AIS system in the surrounding sea will appear on the radar view as an AIS target.</p>
<p><b>Selected Target</b></p> 	<p><b>Colour: Black / Flashing Coloured Frame</b> Use the arrow keys to select any target on the radar view. After selected, press &lt;ENT&gt; and the detailed information on each target can be viewed.</p>
<p><b>Dangerous Target</b></p> 	<p><b>Colour: Red / Circled Frame</b> When distance to a ship is smaller than CPA/TCPA, the target will be circled in RED. Use the arrow keys to select the dangerous target and to view its detailed information.</p>
<p><b>Friend Ship</b></p> 	<p><b>Colour: Magenta</b> If any pre-stored Friend Ship is nearby, the Friend Ship will appear in Magenta on the radar view.</p>





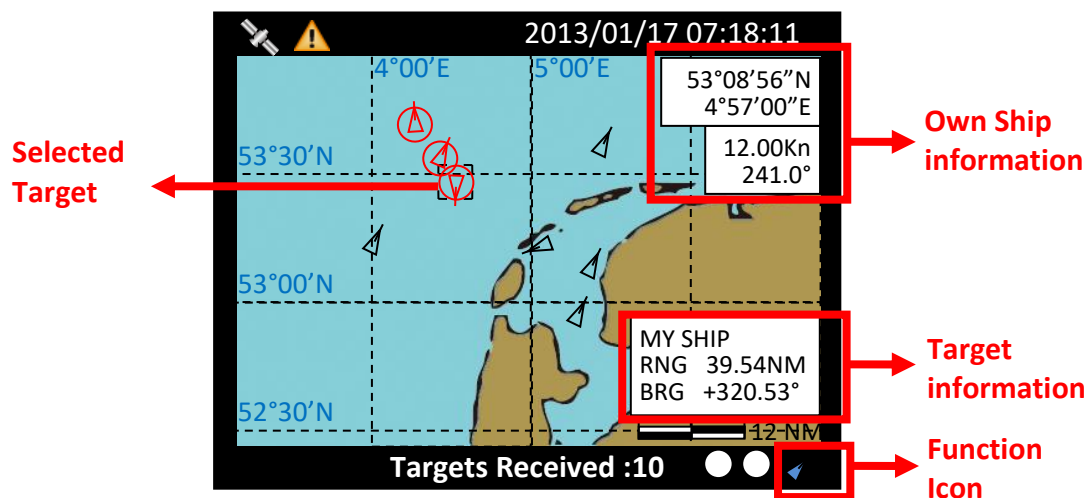

<b>Lost Signal Target</b> 	<b>Colour: Black / Red Cross</b> If reception of an AIS target <b>has ceased</b> over 10 minutes, a “X” will be displayed over it. The target will disappear from the Radar View after its reception <b>has ceased</b> for one hour.
<b>AtoN (Real)</b> 	<b>Colour: Black / Plus Sign</b> The icon will be displayed if any AIS AtoN (Aids to Navigation) Real is in the range of reception.
<b>AtoN (Virtual)</b> 	<b>Colour: Black / Plus Sign and Undercut</b> The icon will be displayed if any AIS AtoN (Aids to Navigation) Virtual is in the range of reception.
<b>AtoN (Off position)</b> 	<b>Colour: Red / Plus Sign</b> The icon will be displayed if any AIS AtoN (Aids to Navigation) is in off position status.
<b>SAR</b> 	<b>Colour: Black</b> The icon will be displayed if any air plane is in the range of reception.
<b>SART</b> 	<b>Colour: Red / Cross</b> The icon will be displayed if any SART message is sent out.
<b>Base Station</b> 	<b>Colour: Green</b> The icon will be displayed when any base station is in the reception range.

## 4.2.2 Coastal View



**Figure 19 Coastal View**

Item	Function
<b>Own Ship information</b>	Own-ship information for latitude, longitude, SOG and COG
<b>Target information</b>	Display the target information such as vessel name or MMSI as well as range and bearing relatively to the own ship
<b>Function Icon (Coastal View)</b>	Users can select one of the 5 viewing modes by pressing the FUNC button. Turn the knob to change the selected range, position, AIS target or SART/MOB target
 Zoom In/Out:	The plot range can be adjusted by turning the knob which cycles through the ranges 24, 12, 6, 3, 1.5, 0.75, 0.5, 0.25, 0.125 and 0.05nm.
 Up/Down:	Turn the knob to move the map vertically
 Left/Right:	Turn the knob to move the map horizontally
 Target Selected:	Turn the knob to navigate between different AIS targets, press the knob to see more details of the target.
 SART/MOB:	This icon appears only when valid SART or MOB target is received. Turn the knob to navigate between different SART/MOB targets, press the knob to see more details of the target.



The coastline map in this transponder is neither verified nor approved by Hydrographic Authorities. It is not an Electronic Chart System and therefore should not be used for navigation. The information provided by the coastline map is for reference only and should be used together with other navigation sources and devices.

### 4.2.3 Radar View

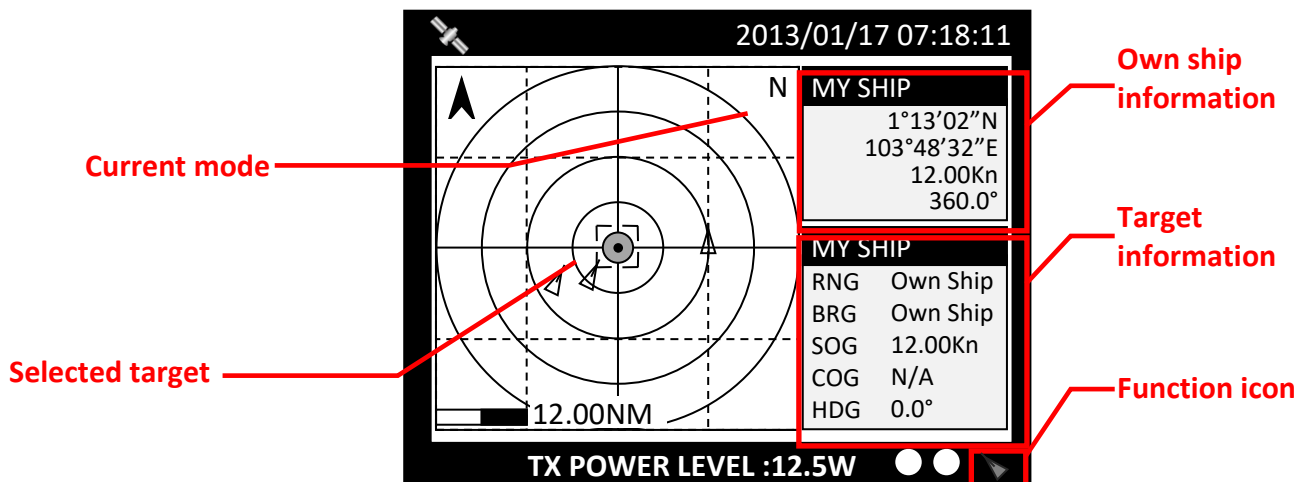

**Figure 20 Radar View**

Radar View displays own ship and target ships' statuses, and their correlations.

On this view, the vertical grid lines are the longitudinal lines and the horizontal grid lines are the latitudinal lines. Underneath the radar view is a proportional chart scale showing the current ratio displayed.

Under Radar View, only 3 function icons are available - Zoom In/Out, Select Target and SART/MOB. The operation with FUNC button is same as described in 4.2.2.

Radar View supports three ship orientation modes, North up, Head up, and Course up. Each orientation mode is indicated by the uppercase letter (N, H, or C) on the right upper corner. The left upper corner is the north arrow indicating the direction of north.

<b>N</b>	<b>NORTH UP</b>	The chart orientation is fixed and true north is always pointing up.
<b>C</b>	<b>COURSE UP</b>	The orientation is determined by the own ship's traveling course.
<b>H</b>	<b>HEAD UP</b>	The orientation is determined by the direction of own ship's bow.

### 4.2.4 Dimmer Setting

Use the button "DIM" to enter the dimmer setting page.

Button	Description
Knob (Turn left/right)	Adjust screen brightness (decrease/increase)
Knob (Press)	Save and leave the page
DIM	Restore screen brightness to default setting (100)
MENU · ESC	Leave the page without saving

## 4.3 Entering Text

The knob on the front control panel is used for entering and editing text. The figures below show the text entering procedures.

- Turn the knob to traverse the menu items up or down. Once selected, press the knob to select the item for text entering.
- Select a character position to edit. Turn the knob to move the cursor left or right and press the knob to confirm the position.
- System is now in character selection mode as the cursor position is highlighted. Turn the knob to pick an available character and press the knob for character selection.

	A	B	C	D	E	F	G
H	I	J	K	L	M	N	O
P	Q	R	S	T	U	V	W
X	Y	Z	0	1	2	3	4
5	6	7	8	9	[	\	]
^	_	!	“	#	\$	÷	&
'	(	)	*	+	,	-	.
/	:	;	<	=	>	?	@



**Space is first character for selection**

- Use steps B and C to finish entering all needed characters. To confirm and save, press down the knob and hold for 2 seconds.

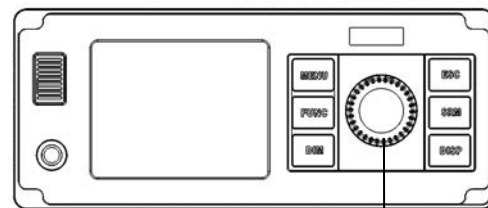

Traverse menu

**A**

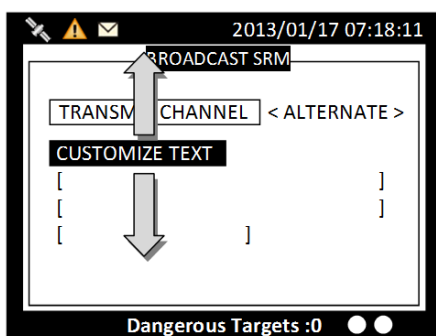

Turn knob to move up or down

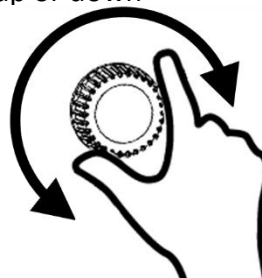

Press to enter



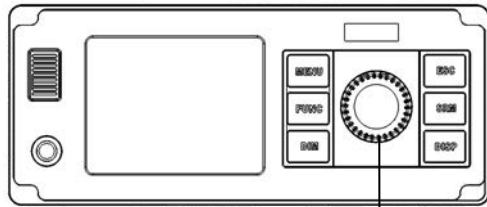

Select a character position

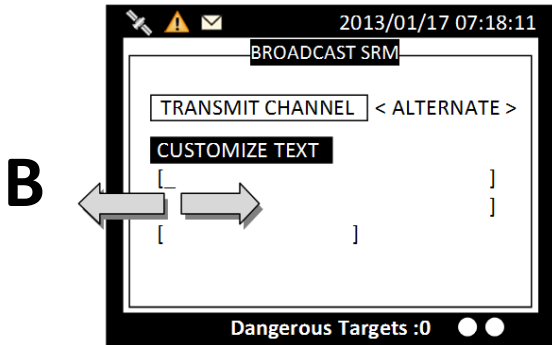

Turn knob to move left or right

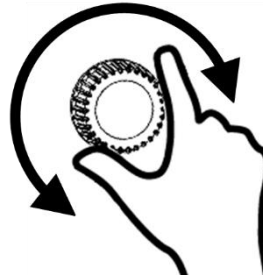

Press to start editing



Pick character

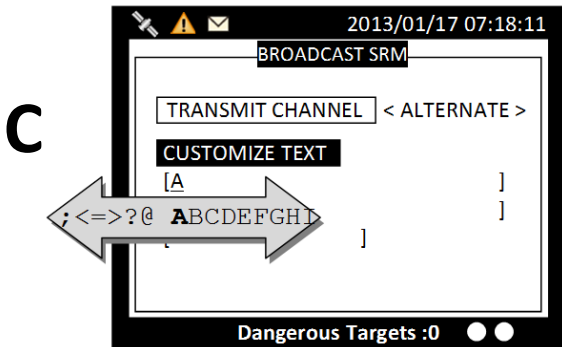

Turn knob to select character

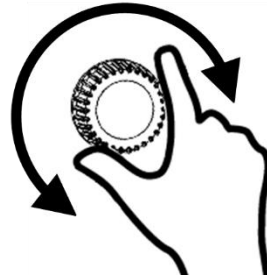

Press knob to confirm

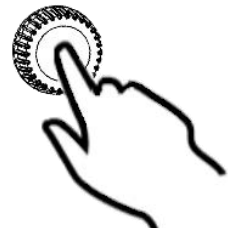

Confirm and save

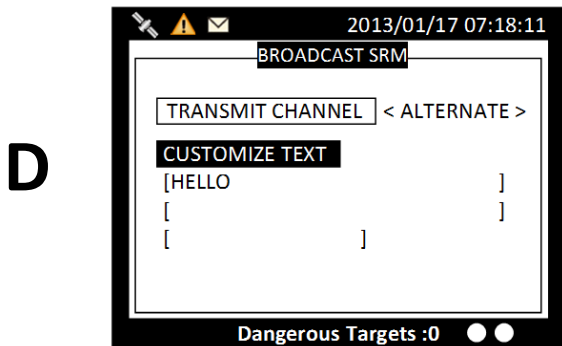

To save entered text, long press the knob for 2 seconds

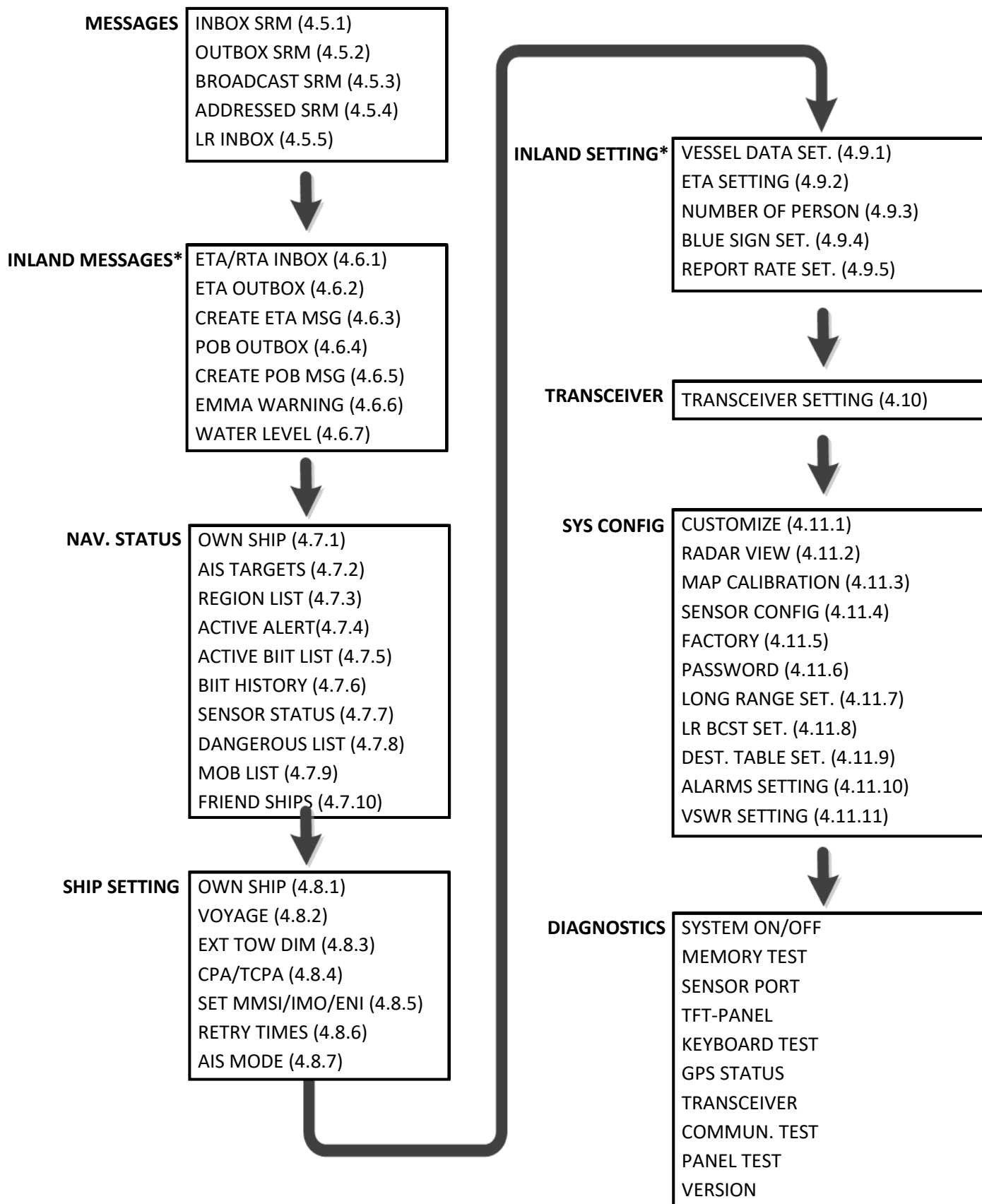

Figure 21

Entering Text

## 4.4 Menu Tree Overview

Press **MENU** button to enter **MAIN MENU**. Please note inland menus, Inland Messages and Inland Settings, are only available when the unit operates under inland mode.



\* Inland mode only

#### 4.4.1 How to access and use MAIN MENU

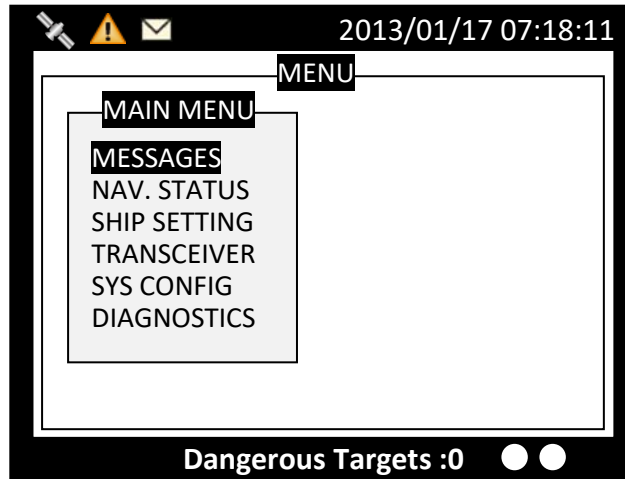

**Figure 22 Main Menu**

Rotate knob to select **MAIN MENU** items and push the knob to select sub-menu items.

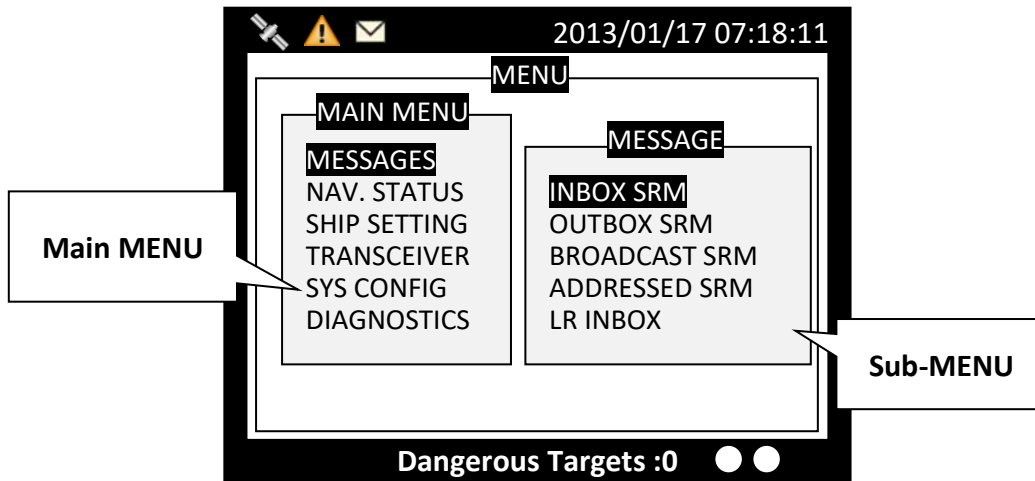

**Figure 23 Submenu**

#### 4.4.2 Menu Item Brief Description

<b>MESSAGES</b>	
<b>INBOX SRM</b>	Log of safety related messages (SRM) received
<b>OUTBOX SRM</b>	Log of safety related messages (SRM) sent
<b>BROADCAST SRM</b>	Send SRM.
<b>ADDRESSED SRM</b>	Send specified targeted SRM.
<b>LR INBOX</b>	Log of received inquiry messages from others.
<b>INLAND MESSAGES</b>	
<b>ETA/RTA INBOX</b>	Log of ETA(RFM21), RTA(RFM22) message received
<b>ETA OUTBOX</b>	Log of ETA(RFM21) sent
<b>CREATE ETA MSG</b>	Create ETA(RFM21) message
<b>POB OUTBOX</b>	Log of PERSON message (RFM55 or IFM16) sent
<b>CREATE POB MSG</b>	Create PERSON message (RFM55 or IFM16)
<b>EMMA WARNING</b>	Log of EMMA warning (RFM23) received
<b>WATER LEVEL</b>	Log of WATER LEVEL (RFM24) received
<b>NAVIGATION STATUS (Display a variety of navigation information)</b>	
<b>OWN SHIP</b>	Your vessel information
<b>AIS TARGETS</b>	Navigation status and boat information of other AIS-equipped vessels.
<b>REGION LIST</b>	Regional information status
<b>ALARM LIST</b>	Alarm information, To access Alarm List directly press and hold ESC button for 2 seconds
<b>ALARM HISTORY</b>	Alarm history record
<b>SENSOR STATUS</b>	Display sensor statuses
<b>DANGEROUS LIST</b>	Dangerous ship list
<b>MOB LIST</b>	MOB list of registered MOB users
<b>FRIEND SHIPS</b>	Friend ship list
<b>SHIP SETTING (Basic vessel information setting)</b>	
<b>OWN SHIP</b>	Your vessel setting (password required, default is 0000)
<b>VOYAGE</b>	Navigation setting
<b>CPA / TCPA</b>	CPA / TCPA
<b>SET MMSI / IMO / ENI</b>	Change MMSI / IMO / ENI number
<b>RETRY TIMES</b>	Times to resend messages.
<b>AIS MODE</b>	Configure AIS Mode to SOLAS or INLAND
<b>INLAND SETTING</b>	
<b>VESSEL DATA SET.</b>	Configure Vessel data
<b>ETA SETTING</b>	Configure ETA



<b>NUMBER OF PERSON</b>	Set number of persons
<b>BLUE SIGN SET.</b>	Set Blue sign settings
<b>REPORT RATE SET.</b>	Set report rate settings
<b>TRANSCEIVER (Settings for AIS receiving and sending)</b>	
<b>AIS TX</b>	Transceiver status: turn on or off AIS message transmitting
<b>DSC RX</b>	DSC Monitor: turn on or off DSC monitoring function
<b>GPS ANT. VOLTAGE</b>	GPS antenna feeding voltage: set to 3.3V or 5V Note:- Antenna supplied with unit is a 3.3V unit
<b>SYSTEM CONFIGURATION</b>	
<b>CUSTOMIZE</b>	Personalization settings
<b>RADAR VIEW</b>	Radar configuration
<b>MAP CALIBRATION</b>	Map offset setting
<b>SENSOR CONFIG.</b>	Port configuration
<b>FACTORY</b>	Default factory setting
<b>PASSWORD</b>	Password change (default password: 0000)
<b>LONG RANGE SET.</b>	Remote inquiry setting
<b>LR BCST SET.</b>	Enable/Disable Long Range Broadcast
<b>DEST TABLE SET.</b>	Table storing destinations
<b>ALARMS SETTING</b>	Configure ALR sentence status (Enable/Disable)
<b>VSWR SETTING</b>	VSWR setting
<b>DIAGNOSTICS</b>	
<b>SYSTEM ON/OFF</b>	Device activated log
<b>MEMORY TEST</b>	Memory test
<b>SENSOR PORT</b>	Transmission port test
<b>TFT-PANEL</b>	Screen panel
<b>KEYBOARD TEST</b>	Button test
<b>GPS STATUS</b>	GPS positioning status
<b>TRANSCEIVER</b>	Transponder status
<b>COMMUN. TEST</b>	Test communication
<b>PANEL TEST</b>	Test Panel
<b>VERSION</b>	Firmware version

## 4.5 Messages

The M5 features SRM alert pop-ups that can appear any time during operation. When a SRM (Safety Related Messages) from other AIS equipped vessels is received, you can either read and acknowledge it by pressing the knob or ignore the message by press **ESC**. If there is any unread message, the upper left corner will display , the new message icon. An example of a pop-up SRM message is shown below.

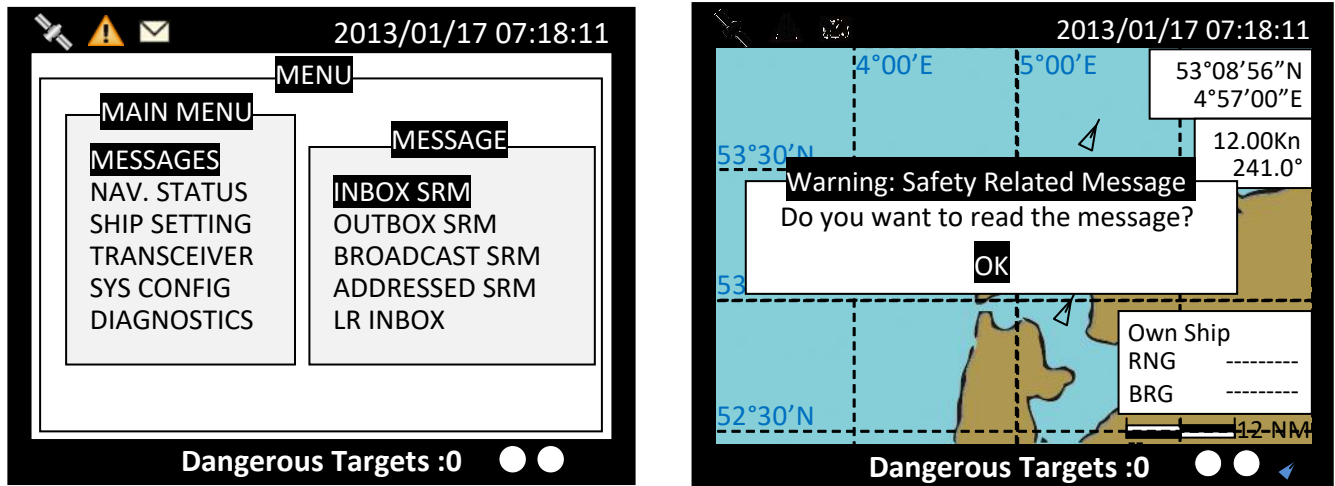

Figure 24 Message and SRM pop-up alert

### 4.5.1 Inbox SRM

You can read received SRM messages under **Inbox**. Turn the knob to traverse the message list and highlight your choice. Read the message content by pressing the knob.

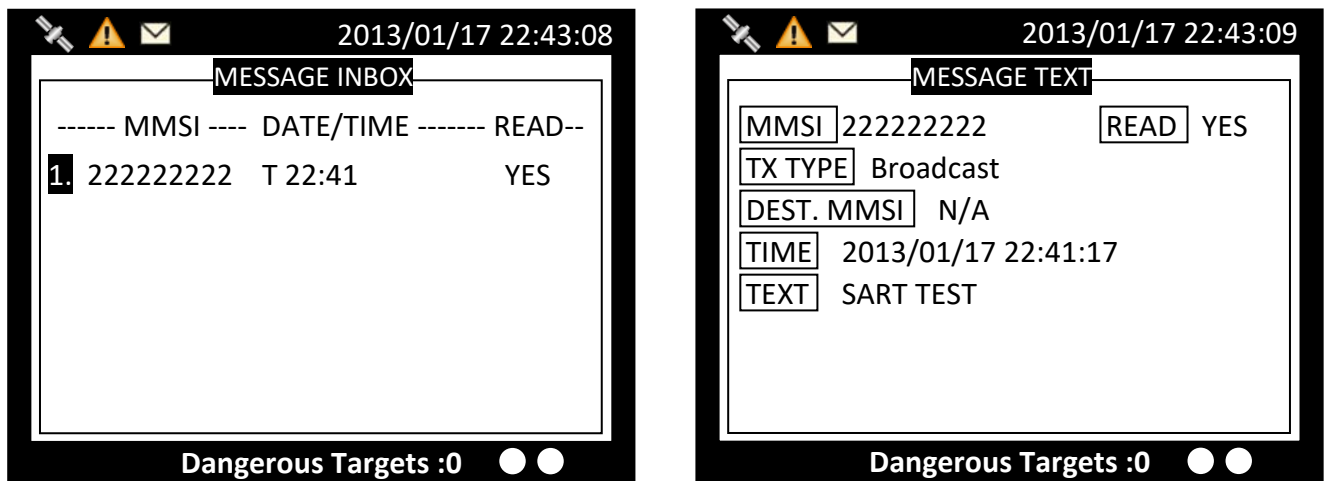

Figure 25 Received message list and message details

When pressing the **FUNC** button, system will ask whether the highlighted message should be deleted. Press knob to confirm your choice.

## 4.5.2 Outbox SRM

You can read all sent **SRM** messages under **OUTBOX**. Turn the knob to traverse the message list and highlight your choice. Read the message content by pressing the knob.

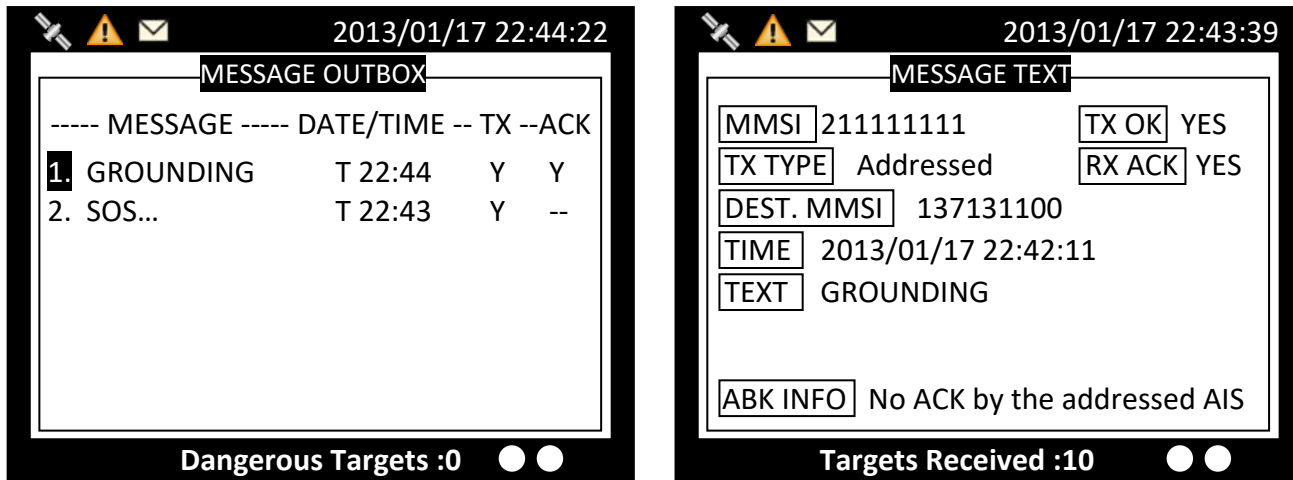

Figure 26 Sent message list and message details

When pressing the **FUNC** button, system will ask whether the highlighted message should be deleted. Press knob to confirm your choice.

When an addressed message is sent, the addressee will return an acknowledgement upon receipt of the message. The received acknowledgement is shown as “Y” in Figure 26 .

## 4.5.3 Broadcast SRM

This submenu allows the users to compose a Safety Related Message (SRM). Maximum length for the message is 90 characters. TRANSMIT CHANNEL gives you the option to send the message through channel A, B or Alternate. By Alternate, which is the default option, the system will select the channel automatically.

Press the knob to enter text input mode, then use the knob to enter text. When text editing is finished, press ESC to leave the text input mode.

To send the message, press **MENU** or **ESC** and the system will ask whether to send the message. Select **OK** to send, **CANCEL** to cancel and return to main menu.

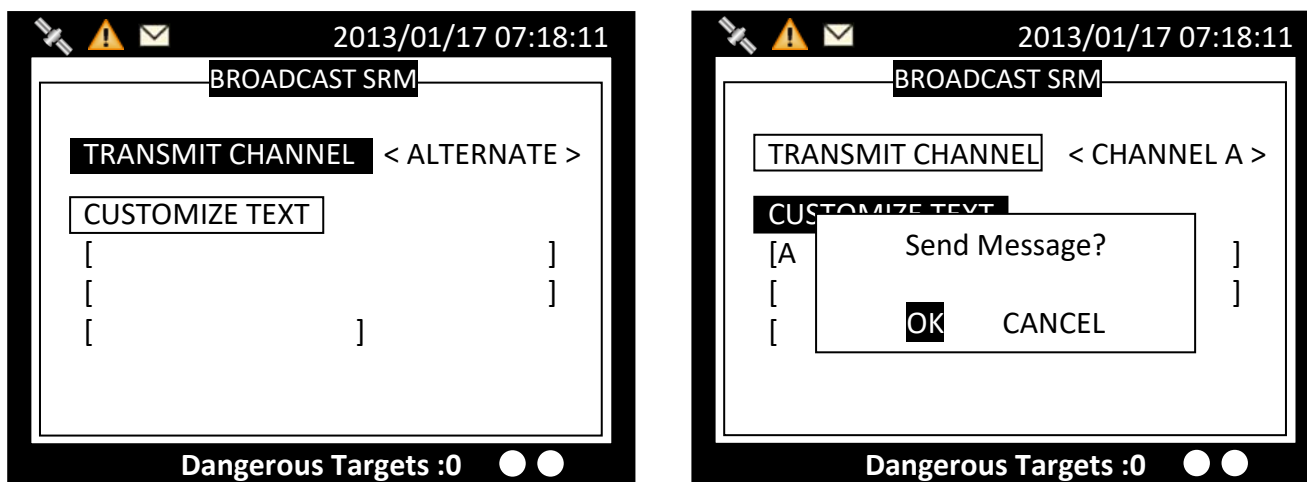

Figure 27 Edit and send Broadcast SRM

## 4.5.4 Addressed SRM

**ADDRESSED SRM** means a SRM addressed to a certain MMSI number which can be selected from the target list or input manually. By entering into the submenu “ADDRESSED SRM”, users will be prompted to select the addressee from the target list. Here you can either pick the addressee or press ESC to leave the target list and enter the MMSI number manually.

Press the FUNC button and you have the possibility to add the selected vessel to your friend list, or to sort the list by MMSI, range or bearing. Please refer to 4.7.2 for more details.

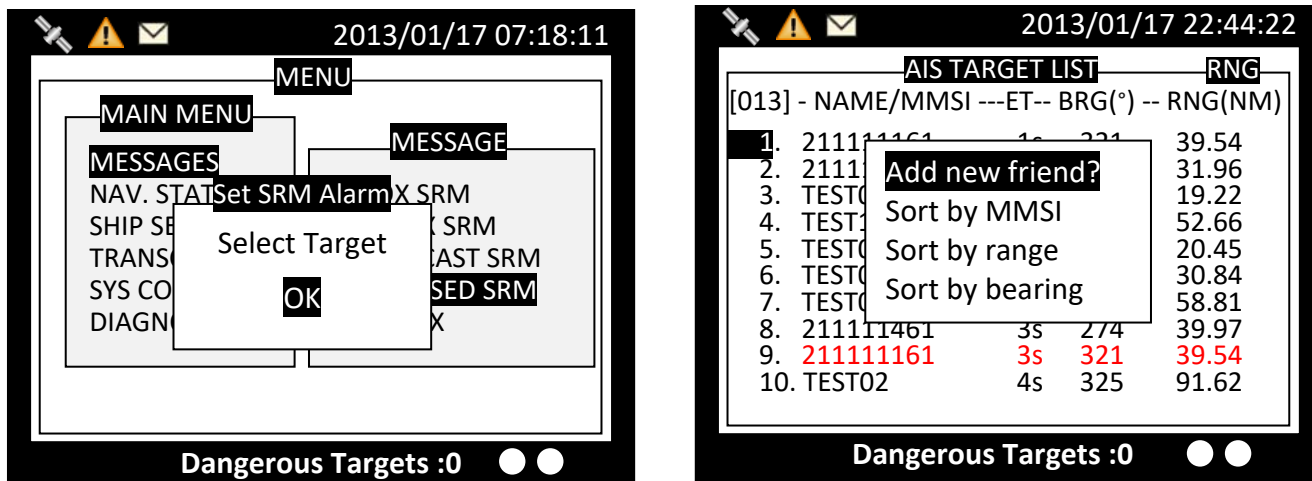

Figure 28 Addressed SRM

After entering the MMSI number, choose the transmit channel as described in 4.5.3, then compose the message. Maximum length for the message is 85 characters.

To send the message, press **MENU** or **ESC** and the system will ask whether to send the message. Select **OK** to send, **CANCEL** to cancel and return to main menu.

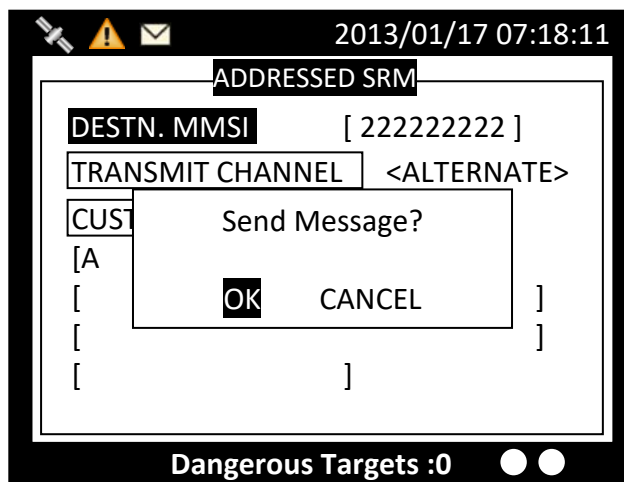

Figure 29 Send Message

## 4.5.5 Long Range SRM

When the transponder is connected to a long range communication system via the long range communication port then long range interrogations may be received. These are requests for information from a distant base station beyond normal AIS operation range. **LONG RANGE SRM** holds all received Long Range Interrogation messages.

Turn the knob to traverse the message list.

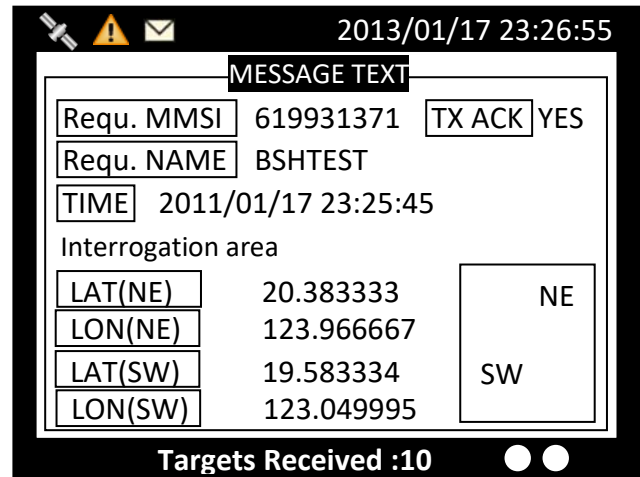

Figure 30 Long Range SRM

Turn the knob to traverse the message list and highlight your choice. Read the message content by pressing the knob.

When pressing the **FUNC** button, system will ask whether the highlighted message should be deleted. Press knob to confirm your choice.

## 4.6 Inland Messages

The M5 has capability to send Inland ETA (Estimated Time of Arrival) messages and receive Inland RTA (Recommended Time of Arrival) messages which are used when communicating with ports, locks and bridges on the inland water ways. Note that the menu is only available when the unit is operating under inland mode.

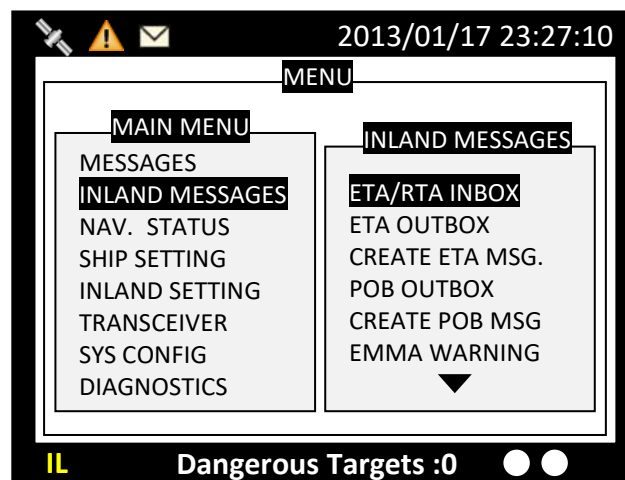

Figure 31 Inland Message

## 4.6.1 ETA/RTA Inbox

The received messages of ETA (RFM21) and RTA (RFM22) can be read in the ETA/RTA Inbox. Turn the knob to traverse the message list and highlight your choice. Read the message content by pressing the knob.

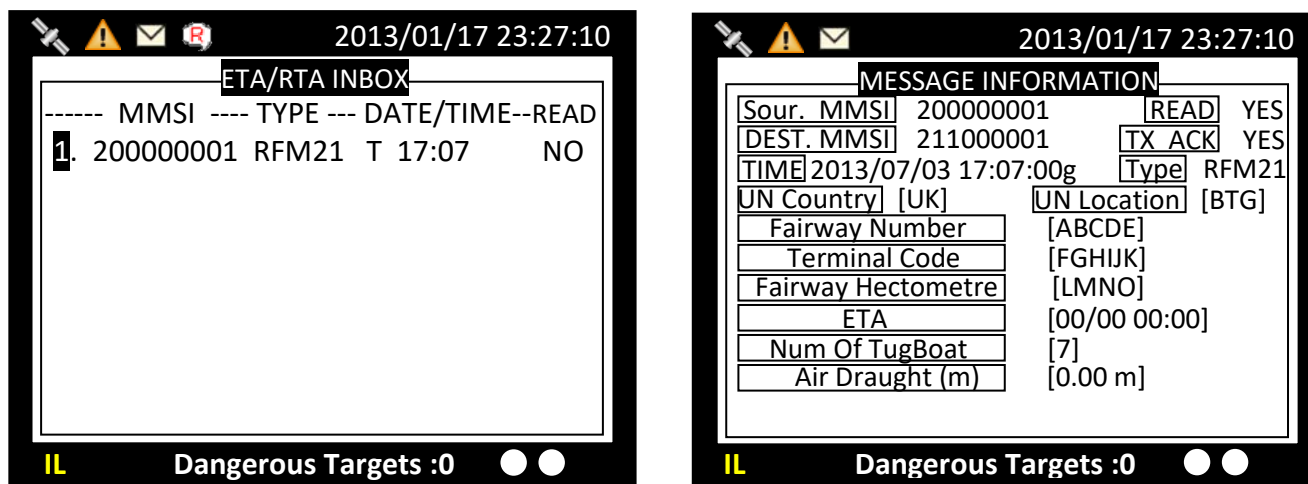

Figure 32 ETA/RTA Inbox and Message Information

## 4.6.2 ETA Outbox

The submenu displays log of sent ETA (RFM21) messages. Turn the knob to traverse the message list and highlight your choice. Read the message content by pressing the knob.

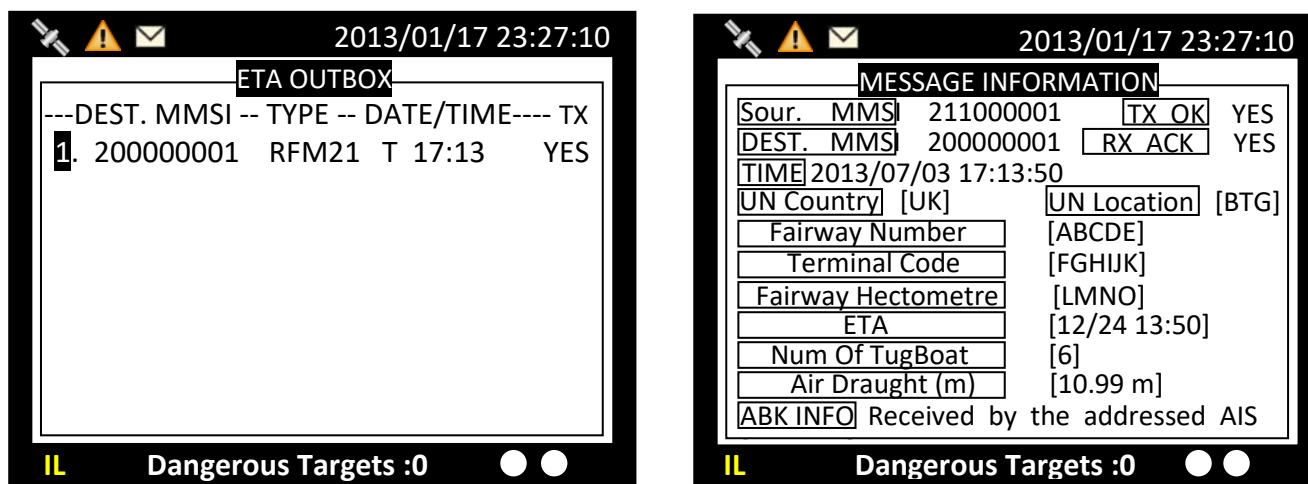

Figure 33 ETA Outbox and Message Information

## 4.6.3 Create ETA Message

For more information about ETA settings, please refer to 4.9.2.

In this submenu users can compose ETA (RFM21) message. By entering into the submenu, users will be prompted to select the addressee from the target list. Here you can either pick the addressee from the list or press ESC to leave the target list and enter the MMSI number manually. **TX CHANNEL** gives you the option to send the message through channel A, B or Alternate. By Alternate, which is the default option, the system will select the channel automatically. After ETA (RFM21) transmitted, if no RTA (RFM22) is received within 15 minutes, transponder will transmit ETA (RFM21).

After the addressee is selected, you can configure the ETA message.

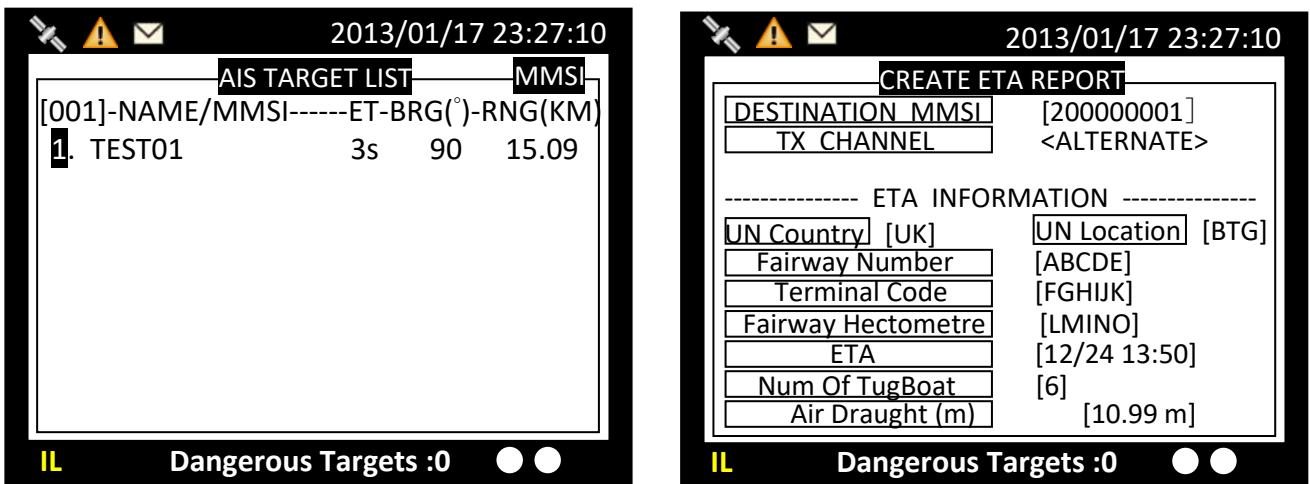

Figure 34 Target Selection and ETA Report

#### 4.6.4 POB Outbox

The submenu displays log of sent Number of person on board (RFM55/IFM16) messages. The IMO version sends the total number of persons on board as a binary message with international IFM16.

The Inland (IWW) version sends a message with number of crew, personnel and passengers as a binary message with inland branch RFM55.

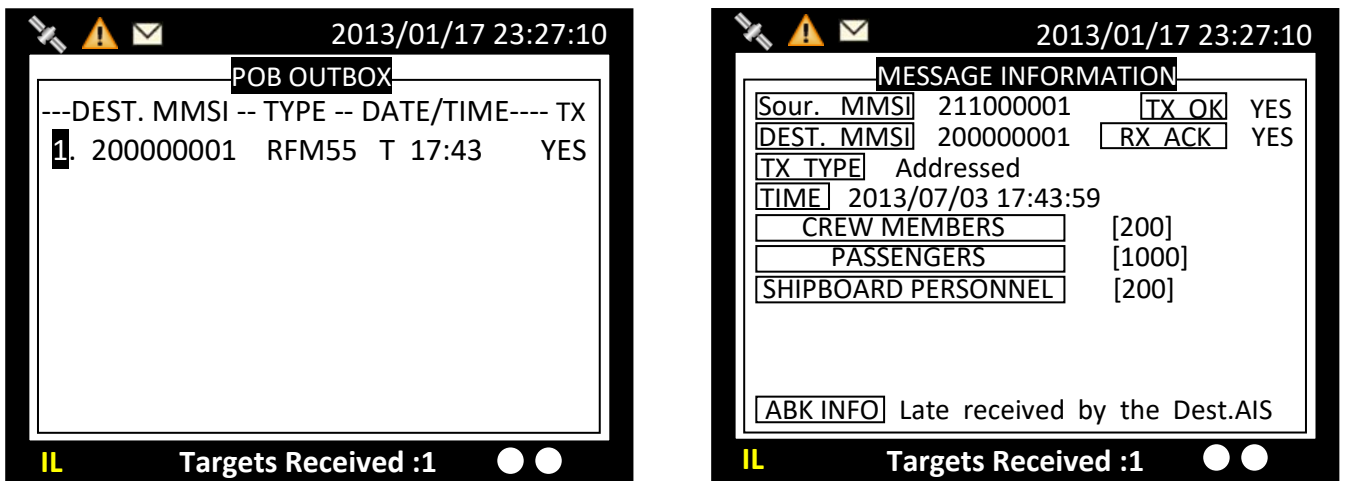

Figure 35 POB Outbox and POB Message Information

Use the knob to select a message and press the knob to display message content.

## 4.6.5 Create POB Message

In this submenu users can compose number of person on board (RFM55/IFM16) messages. Number of person on-board can be configured in Inland Setting 4.9.3.

By entering into the submenu, users will be prompted to select the addressee from the target list. Here you can either pick the addressee from the list or press ESC to leave the target list to enter the MMSI number manually or broadcast the POB message without specifying any addressee. When "Broadcast" is selected, just omit the DESTINATION MMSI. Any entered number will be ignored.

The **DATA TYPE** provides the option either to send the data in RFM16 or RFM55, as described in 4.6.4.

**Tx CHANNEL** gives you the option to send the message through channel A, B or Alternate. By Alternate, which is the default option, the system will select the channel automatically.

After ETA (RFM21) transmitted, if no RTA (RFM22) is received within 15 minutes, transponder will transmit ETA (RFM21).

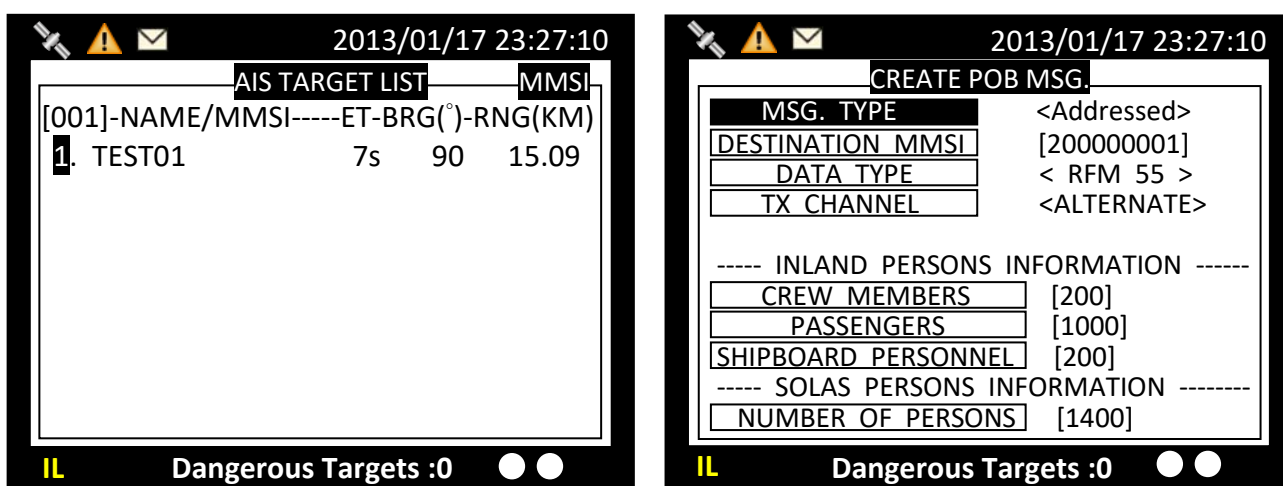

Figure 36 Target List and POB Message Content

## 4.6.6 EMMA Warning

The submenu displays log of EMMA warning (RFM23) messages. EMMA (European Multiservice Meteorological Awareness system) Information is transmitted as broadcast message from shore to ship as local weather warnings.



Figure 37 EMMA Warning log and Message Content

Use the knob to select a message and press the knob to display message content.



## 4.6.7 Water Level

This submenu displays received water level (RFM24) messages from base station to ship about local water level information.

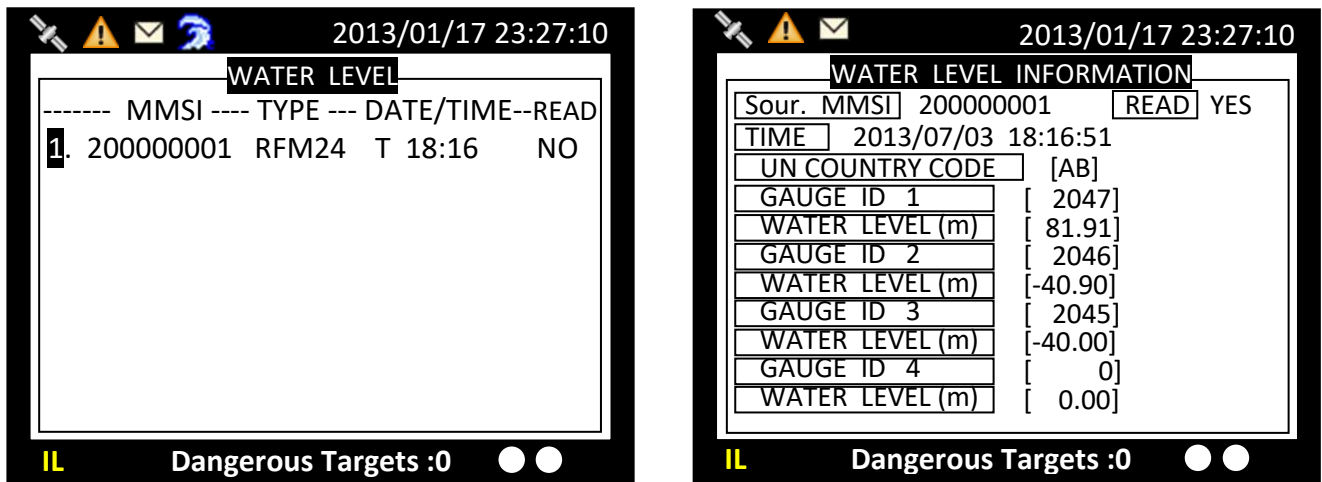

**Figure 38 Water Level log and Message Content**

Use the knob to select a message and press the knob to display message content.

## 4.7 Navigation Status

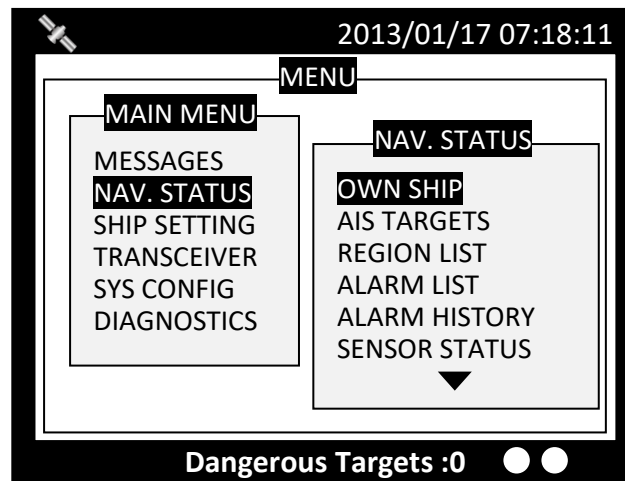

**Figure 39 Navigation Status**

## 4.7.1 Own Ship

This option displays the full information on your ship, including both dynamic and static data. Turn the knob to change between dynamic and static information.

### ■ Static data and Dynamic Data

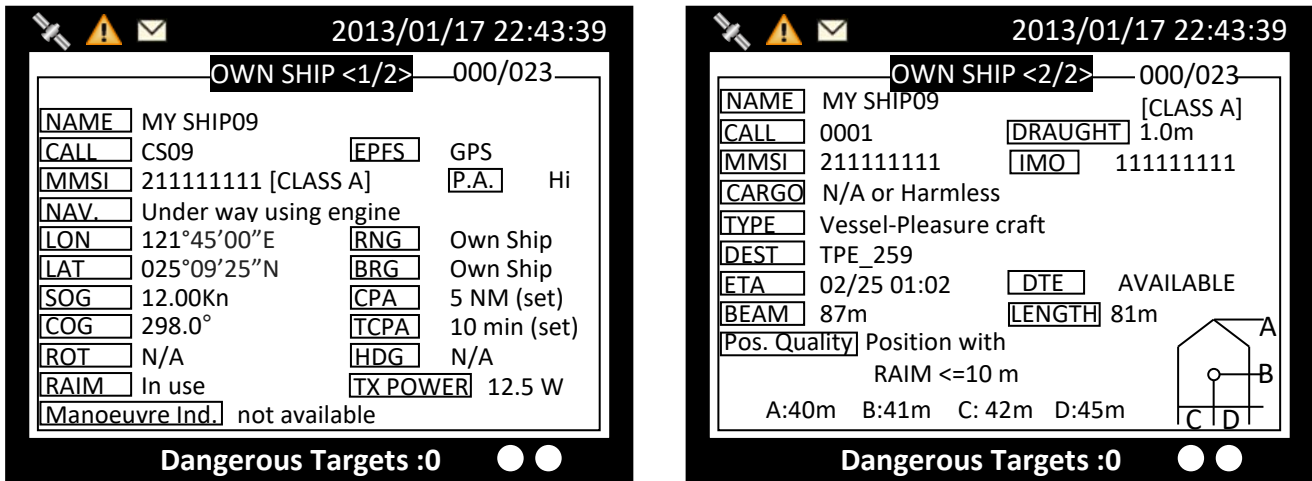

Figure 40 Static Data and Dynamic Data

### Inland Vessel Information

The following information is only available under inland mode.

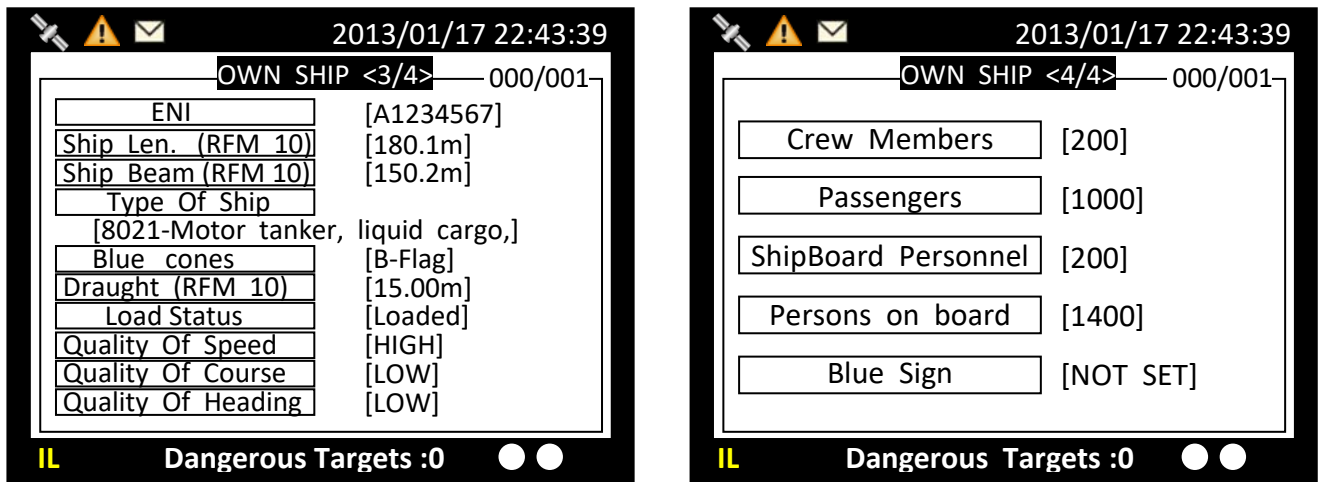

Figure 41 Additional Inland Vessel Information

## 4.7.2 AIS Targets

This option displays all received AIS information of other vessels including dynamic and static information. Press the knob to select an AIS target and then press the knob to go through dynamic and static information of the selected vessel. There are two pages of ship details for SOLAS mode and another two pages for inland mode.

2013/01/17 22:44:22

**AIS TARGET LIST** **RNG**

[013] - NAME/MMSI ---ET-- BRG(°) -- RNG(NM)

1.	MMSI	ET	BRG(°)	RNG(NM)
1.	211111161	1s	321	39.54
2.	211111561	1s	314	31.96
3.	TEST05	1s	143	19.22
4.	TEST10	2s	8	52.66
5.	TEST03	1s	293	20.45
6.	TEST06	1s	30	30.84
7.	TEST08	2s	342	58.81
8.	211111461	3s	274	39.97
9.	211111161	3s	321	39.54
10.	TEST02	4s	325	91.62

Dangerous Targets :0

2013/01/17 22:43:39

**SHIP DETAIL <1/2>** 006/023

NAME	TEST12	EPFS	Undefined
CALL	TEST12	P.A.	Lo
MMSI	211000601 [CLASS A]		
NAV.	Under way using engine		
LON	121°54'59"E	RNG	10.61NM
LAT	025°12'37"N	BRG	80°
SOG	26.00Kn	CPA	pass
COG	350.8°	TCPA	pass
ROT	N/A	HDG	351.8°
RAIM	Not in use		
Manoeuvre Ind.	not available		

Dangerous Targets :0

Figure 42 AIS Targets and details

Additional inland information is available under inland mode.

2013/01/17 22:43:39

**SHIP DETAIL <3/4>** 001/001

ENI	[00000000]
Ship Len. (RFM 10)	[0.0 m]
Ship Beam (RFM 10)	[0.0 m]
Type Of Ship	[8000-Vessel, type, unknown]
Blue cones	[Unknown]
Draught (RFM 10)	[0.00 m]
Load Status	[Unknown]
Quality Of Speed	[LOW]
Quality Of Course	[LOW]
Quality Of Heading	[LOW]

IL Dangerous Targets :0

2013/01/17 22:43:39

**SHIP DETAIL <4/4>** 001/001

Crew Members	[0]
Passengers	[0]
ShipBoard Personnel	[0]
Persons on board	[0]
Blue Sign	[NOT AVAILABLE]

IL Dangerous Targets :0

Figure 43 Ship's Inland Information

## Adding Friend Ship

In the list, press **FUNC** button will open the pop-up window with the question whether the selected vessel should be added to your **FRIEND SHIP** list, or to sort the list according to vessels' MMSI, distance, or direction.

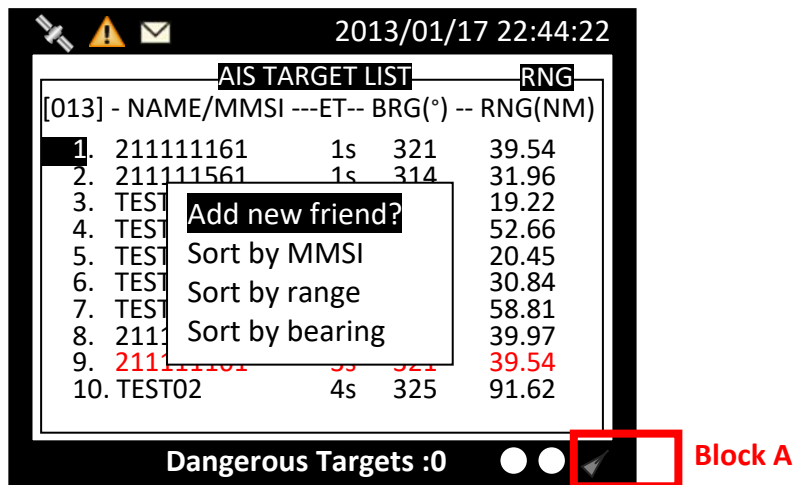

**Figure 44 Adding Friend Ship**

In the screenshot above, the block A indicates the current sorting method.

	By MMSI, in ascending order
	By direction, in ascending order
	By distance, in ascending order

### 4.7.3 Region List

The region list displays all saved region areas. Turn the knob to traverse the list. Press the knob enables you to read the highlighted region information.

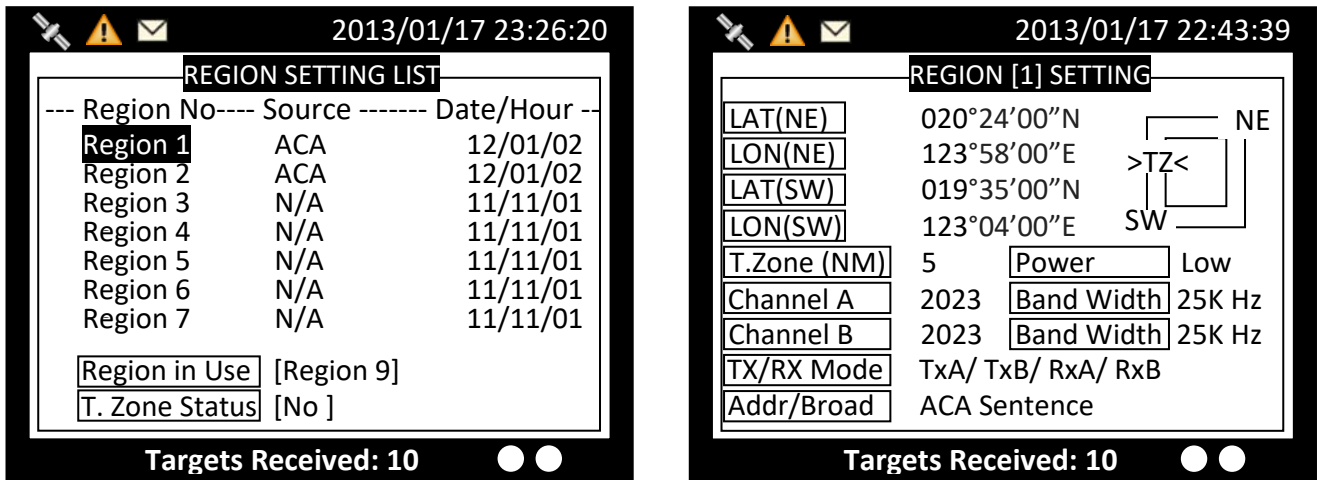

Figure 45 Region List and Region Setting

#### Editing existing region content

you can modify the region area setting by pressing **FUNC** button at the region information page. Use the scroll wheel to scroll to the field to edit, then press the knob to enter the value.

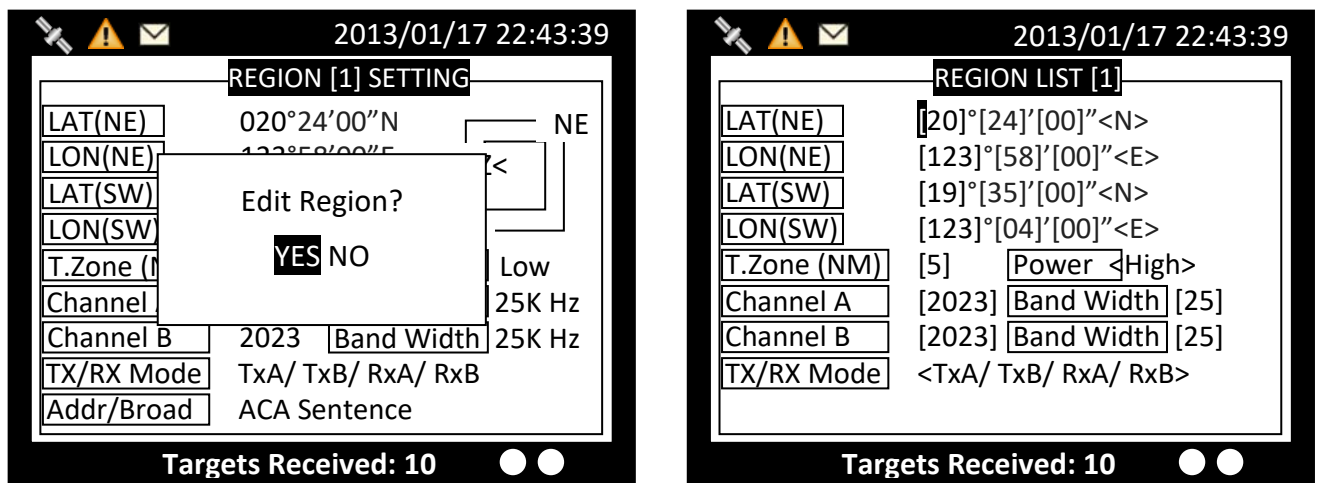



Figure 46 Modify Region Content

To save the settings, press **MENU** or **ESC** and the system will ask whether the changes should be saved. Select **OK** to save or **CANCEL** to discard and return to main menu. If the region information is unchangeable, saving does not change the original information.

## 4.7.4 Active Alert

The M5 features SART/MOB alarm that can appear any time during operation. When SART/MOB message is received, the  icon will appear in the status bar with beeping sounds from the beeper. Press any button to stop the sound. An example of an alarm message is shown below.

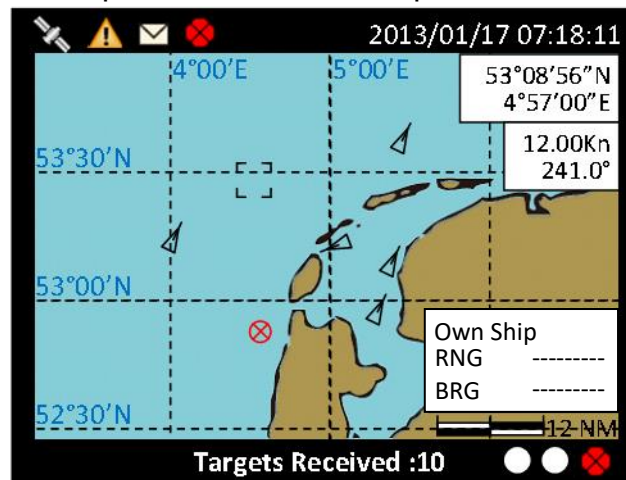



Figure 47 SART/MOB Message Alert

There are 2 ways to access the Active Alert: either through Main Menu/Navigation Status/Active alert or with the hot key by holding the **ESC** key for 3 seconds and the unit will enter the Active alert screen

The list shows all current AIS alerts and their status. Use the scroll wheel to navigate the list. You can acknowledge (**ACK**) the warning (priority: W). The system will ask for confirmation if the chosen alert should be acknowledged. If the alert active, an indication icon  will appear on left upper corner. If the warning "active – unacknowledged" activated, icon  will flashing till all acknowledgement are made.

The display priority order, in sequence with the newest alert on top within each display priority, is:

- 1) "active – unacknowledged" and "active silenced" warnings.
- 2) "rectified – unacknowledged" warnings.
- 3) "active – acknowledged" warnings
- 4) "active" cautions.

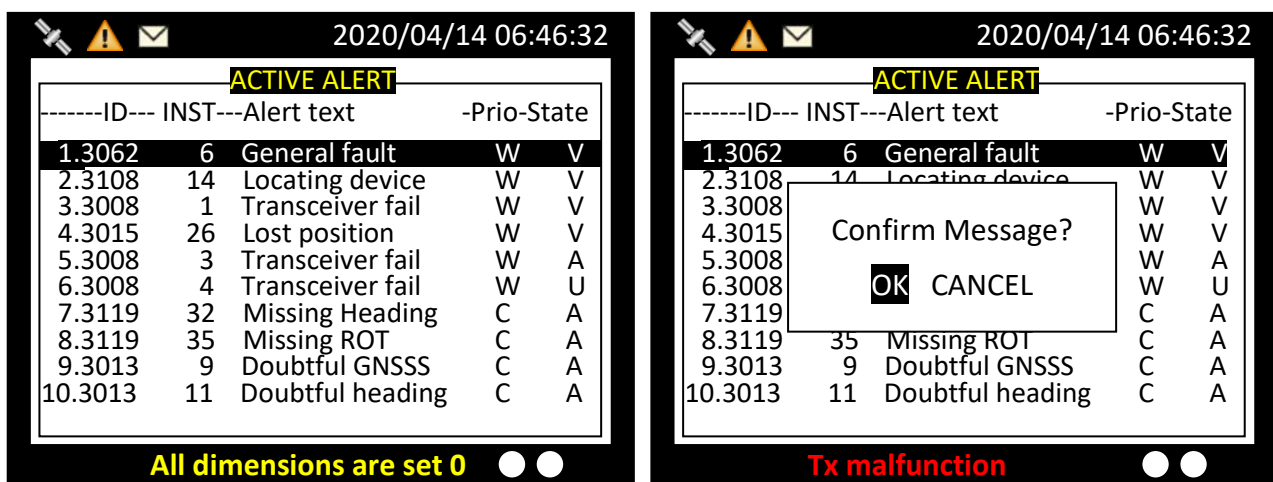

Figure 48 Alarm List (BAM) and acknowledgement

Alert Identifier	Alert text	Additional information	Prio	Cat	Escal	BIIT ID (Alert instance)
3108	Locating device	Check AIS targets	W	B	W	14
3062	General fault	Check AIS equipment	W	B	W	6
3008	Transceiver fail	Not transmitting, check AIS	W	B	W	1
		Not receiving, check AIS	W	B	W	3 、 4
3015	Lost position	Own ship position not transmitted	W	B	W	26
3116	Impaired radio	Reduced coverage (antenna VSWR)	C	B		2
		Ch1 inoperative, check AIS	C	B		3
		Ch2 inoperative, check AIS	C	B		4
		DSC inoperative	C	B		5
3113	Sync in fallback	Check AIS for UTC time synchronisation	C	B		7
3003	Lost ext EPFS	Check external position sensor	C	B		25
3119	Missing COG	Not transmitting COG	C	B		30
	Missing SOG	Not transmitting SOG	C	B		29
	Missing Heading	Not transmitting Heading	C	B		32
	Missing ROT	Not transmitting Rate of Turn	C	B		35
3013	Doubtful GNSS	Int/Ext GNSS position mismatch	C	B		9
	Doubtful heading	Difference with COG exceeds limit	C	B		11
3019	Wrong NavStatus	Check NavStatus setting	C	B		10
3009	Lost MKD	Cannot display safety related messages	C	B		8

Note 1, Alert priority (Prio): W (Warning) 、 C (Caution) 。

**Table – Alert state and audible annunciation for warnings**

Alert state	Audible annunciation
V: active – unacknowledged	2 short audible signals and repeated as a warning after 3 minutes
S: active – silenced	None
A: active – acknowledged	None
U: rectified – unacknowledged	None

**Table – Alert state and audible annunciation for cautions**

Alert state	Audible annunciation
A: active	None

### 4.7.5 Active BIIT List

The M5 features SART/MOB alarm that can appear any time during operation. When SART/MOB message is received, the  icon will appear in the status bar with beeping sounds from the beeper. Press any button to stop the sound. An example of an alarm message is shown below.

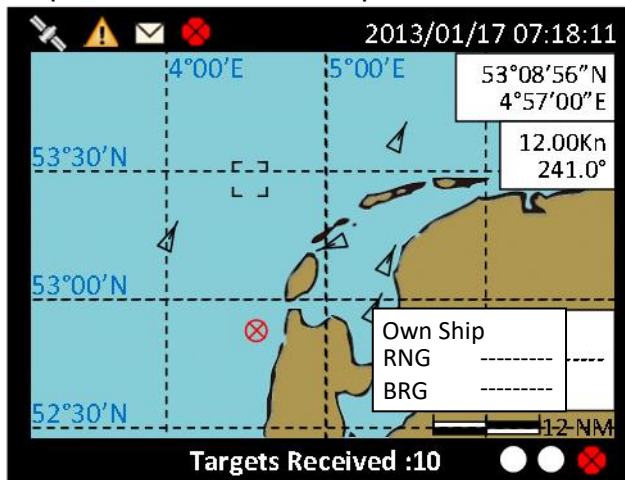

**Figure 49 SART/MOB Message Alert**

The list shows all current AIS alert and their status. Use the scroll wheel to navigate the list. You can acknowledge (**ACK**) the alarm message either by pressing **FUNC** or by pressing the knob. The system will ask for confirmation if the chosen alarm should be acknowledged.

The transponder performs a function self-check continuously. If a self-check fails an alert will occur. The Appendix B.1 shows all possible alert scenarios.

However, the following 4 alerts require user’s immediate attention and will be displayed directly on the Transmission and Reception Bar:

- Tx malfunction: transmission function fails
- Antenna VSWR exceeds limit: VHF antenna malfunction
- NavStatus incorrect:
- Improper MMSI: no valid MMSI
- GPS Antenna Port Short

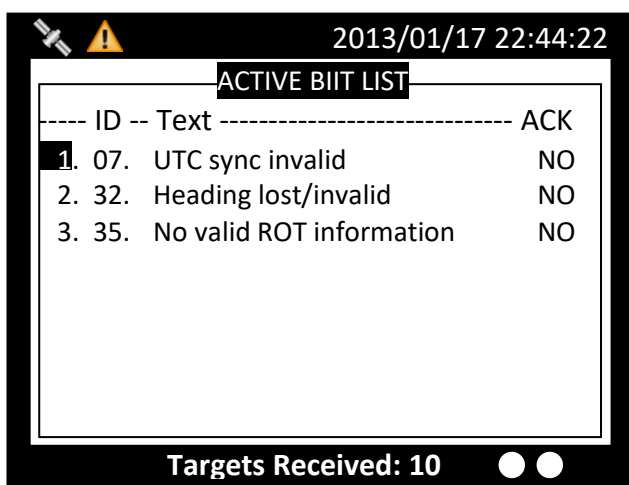

**Figure 50 Active BIIT List and acknowledgement**

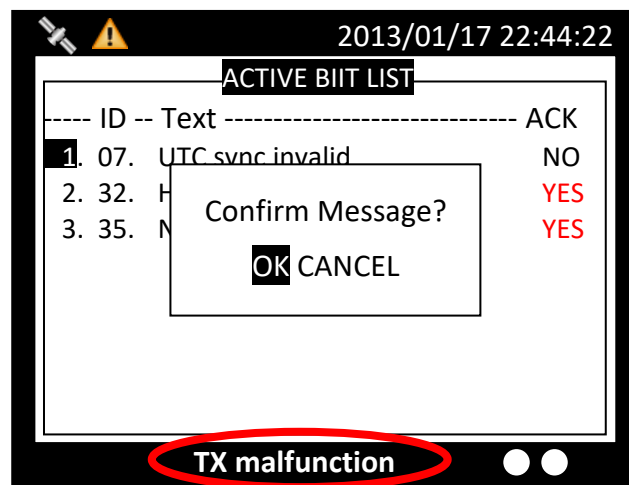



## 4.7.6 BIIT History

This submenu lists all recorded alarm and its time of occurrences.

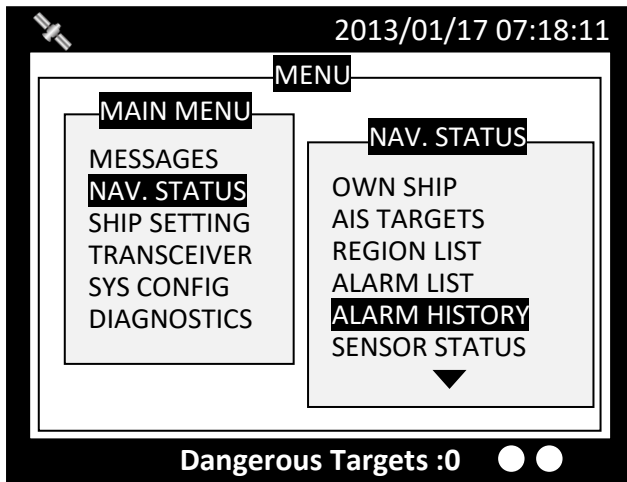
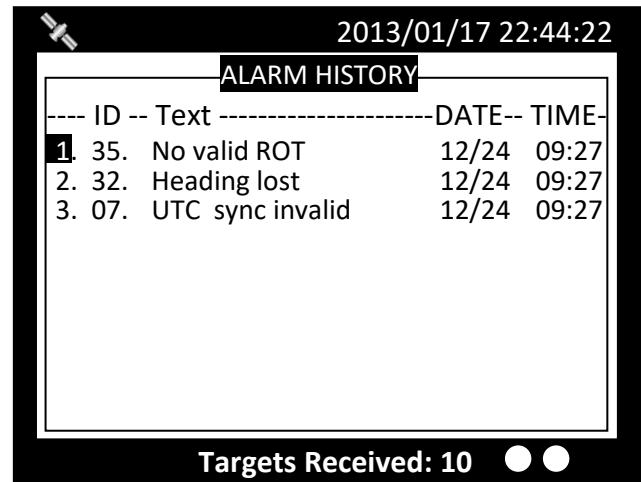

Figure 51



BIIT History

## 4.7.7 Sensor Status

The submenu displays sensor statuses:

SENSOR	STATUS
POSITION STATUS	EXT. DGNSS / INT. DGNSS MSG.17 / EXT. GNSS / INT. GNSS / NO GPS
POSITION QUALITY	No position Manual position Dead reckoning position valid position with no time stamp Position > 10m Position with RAIM > 10 m Position <= 10 m Position with RAIM <= 10 m Outdated position > 200 m
UTC STATUS	VALID / LOST
COG STATUS	INT. COG / EXT. COG / LOST
SOG STATUS	INT. SOG / EXT. SOG / LOST
HEADING STATUS	VALID / LOST
ROT STATUS	VALID / OTHER ROT / LOST
Note 1: If M5 is not connect internal GPS, will lost UTC and time is unsynchronized. The M5 will continue operation using indirect or semaphore synchronization	

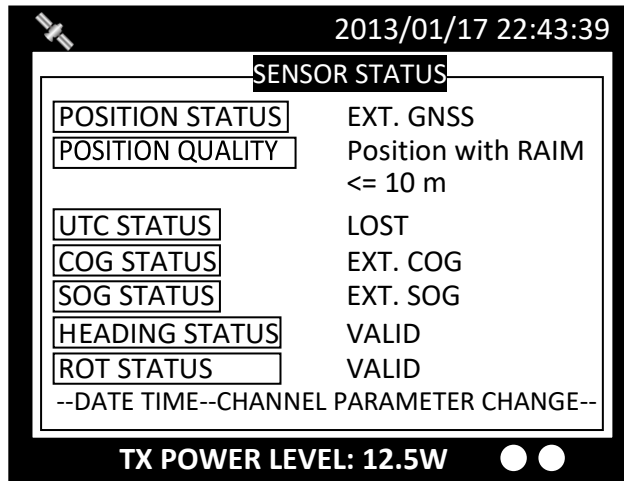

Figure 52 Sensor Status

### 4.7.8 Dangerous List

With the setup of closest point of approach (**CPA**) and time to CPA (**TCPA**) (refer to 4.8.3), this submenu provides an efficient way to monitor vessels with insufficient CPA and TCPA. The dangerous targets can also be observed on coastal and radar view.

Turn the scroll wheel to navigate the list and press the knob to read information of the selected vessel. Turn the **knob** again to go the second page for more details.

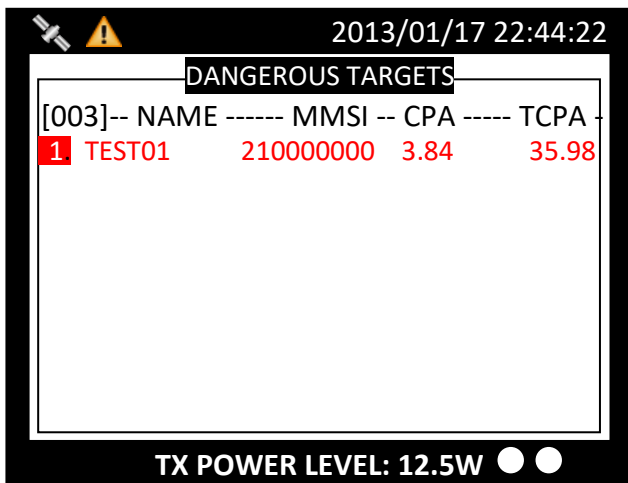
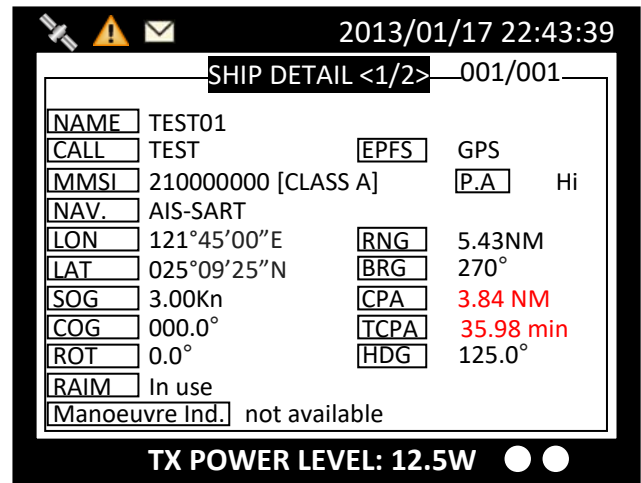

Figure 53 Dangerous List and vessel details



## 4.7.9 MOB List

With the setup of MOB list, MOB can be easily traced by the person's name not just by the MMSI number on the MOB device. This submenu enables adding, removing, or modifying of MOB list entries.

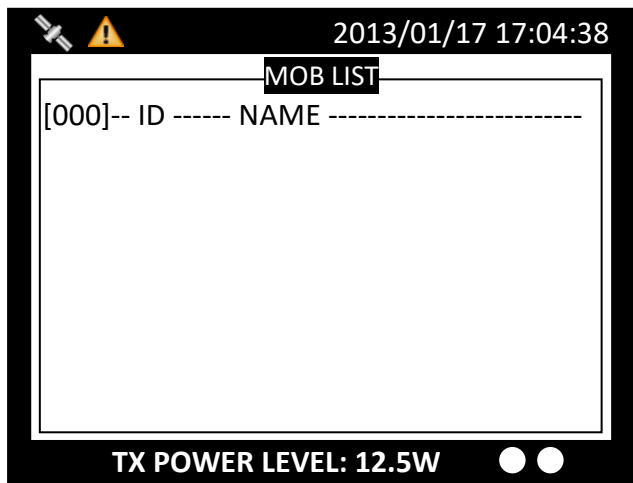
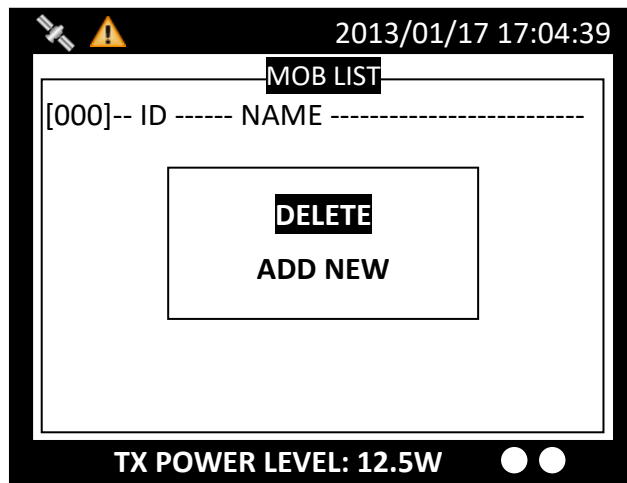

Figure 54



MOB List

In the list, press **FUNC** button will open the pop-up window with the question whether the selected entry should be deleted, or to add a new entry to the list. After MMSI number and name are assigned, press MENU or ESC to save or leave without saving.

The existing entry can be modified by pressing the knob to enter the text edit mode. Use the knob to edit the list and press MENU or ESC to save or leave without saving.

## 4.7.10 Friend Ships

The users can easily recognize the friend ships on coastal view and radar view, when the list of friend ships is set up. This submenu allows you to add, delete and edit the list of all registered friend ships.

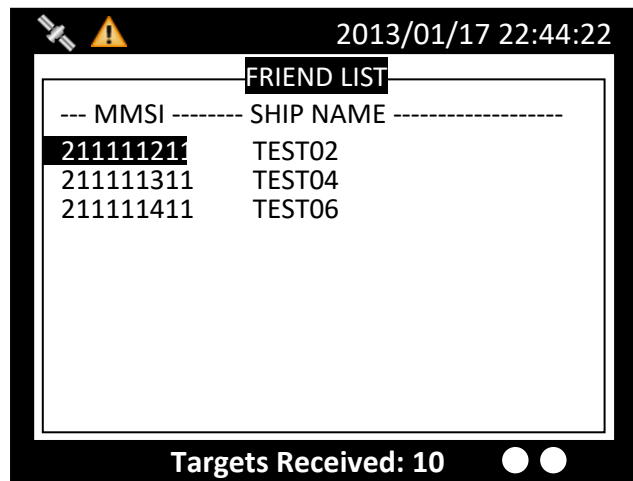
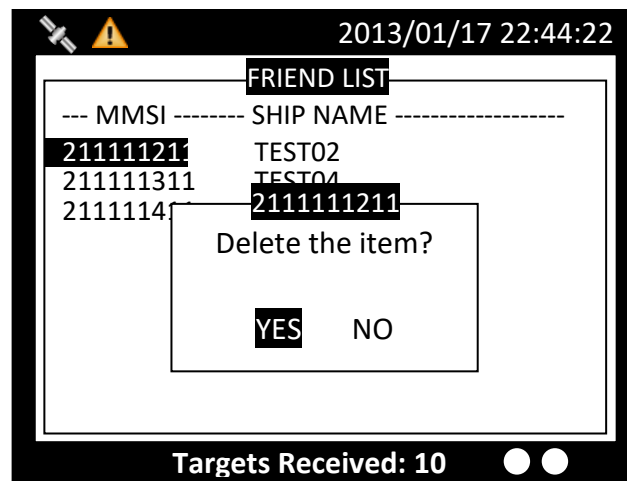

Figure 55



List of Friend Ships

In the list, press **FUNC** button will open the pop-up window with the question whether the selected vessel should be deleted. After MMSI number and name are assigned, press MENU or ESC to save or leave without saving.

The existing entry can be modified by pressing the knob to enter the text edit mode. Use the knob to edit the list and press MENU or ESC to save or leave without saving.

## 4.8 Ship Setting

This menu list provides access to settings that are required during installation of the transponder. There are a total of 5 submenus.

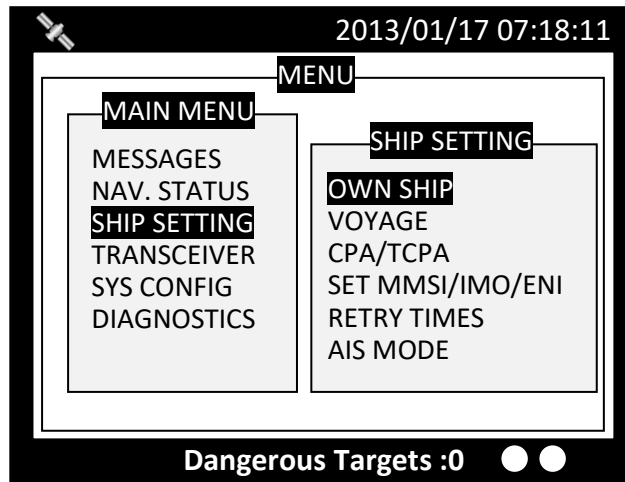

Figure 56 Ship Setting

### 4.8.1 Own Ship

This section is password protected and can only be accessed using the password (see 4.11.6).

The following information about the vessel should be correctly set up by installation prior to operation:

- Call Sign - Vessel radio call sign (limited to 7 characters)
- Ship Name - limited to 20 characters
- Ship Type – use the scroll wheel to select the type of vessel from the list
- Position of internal GPS antenna - giving the location of the GNSS antenna connected to the AIS transceiver (Internal GPS)
- Position of external GPS antenna - giving the location of the GNSS antenna connected to any external position source connected to the AIS transceiver
- Length and Beam – measured length and width of the ship (inland mode only)

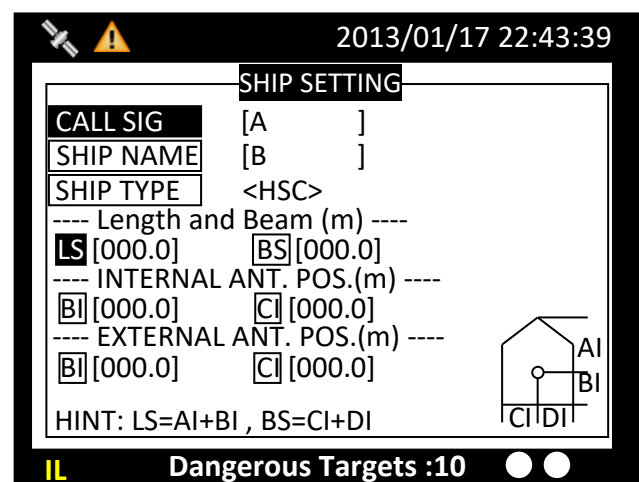
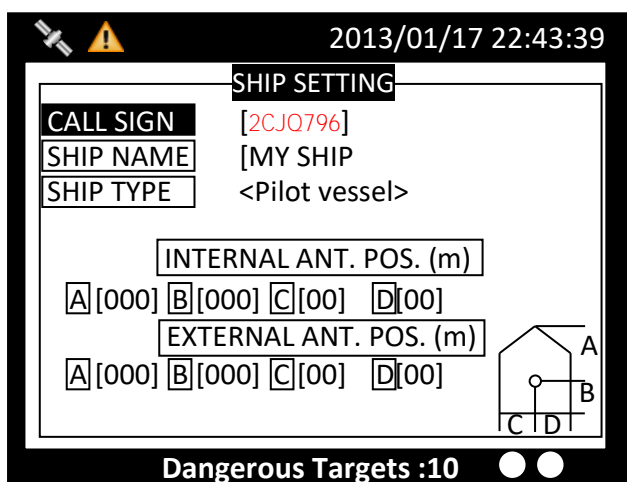
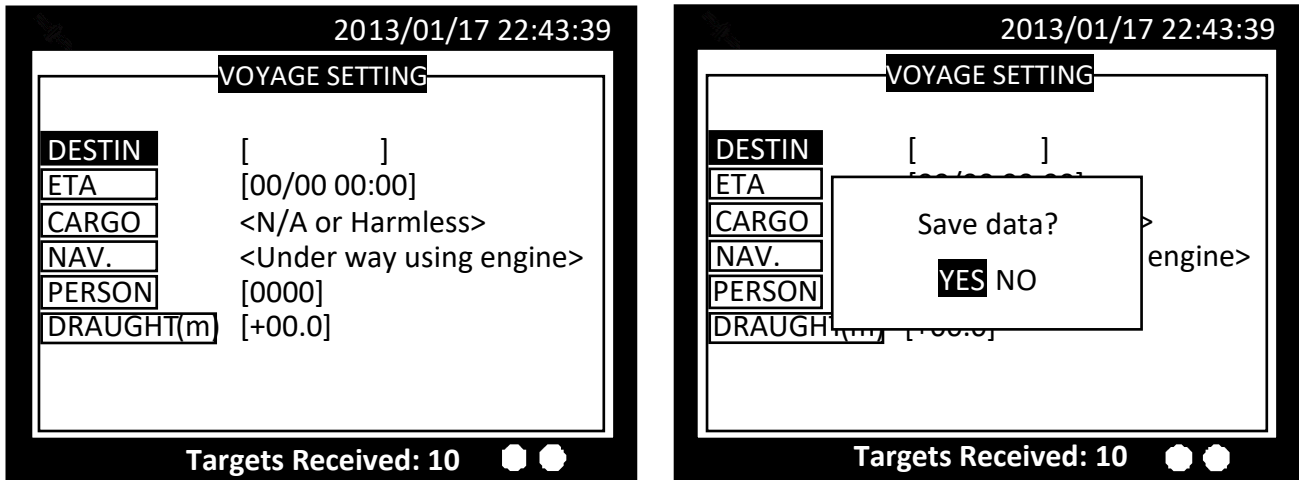

Figure 57 Ship Setting in SOLAS Mode (left) and Inland Mode (right)

**Notice:** if Ship Type is Tanker, by regulation, whenever the ship navigation status is “Moored”, the transponder’s transmission power is automatically changed to 1W for safety measures.

## 4.8.2 Voyage

### 4.8.2.1 SOLAS Mode



**Figure 58 SOLAS Voyage Setting**

In this submenu the following navigational information can be configured:

- Destination – Ship’s next destination port (limited to 20 characters). When destinations are defined in “Destination Table Setting” (see 4.11.9), users can set the Destination by clicking on FUNC button. Each time when the FUNC button is pressed, the Destination displayed will rotate in the order from Column 1 to Column 10 as configured in the table.
- ETA - Estimated time / date of arrival at destination using UTC format MMDDHHMM (excluding year)
- Cargo – use the scroll wheel to select the suitable status from the list
- Navigational status – use the scroll wheel to select the suitable status from the list
- Person – the number of person on board
- Draught - Maximum present static draught to the nearest 1/10th of a metre

Press **MENU** or **ESC** to save the settings.

### 4.8.2.2 Inland Mode

Under inland mode, voyage configuration does not include PERSON setting. To set up number of person on board, please go to INLAND SETTING/NUMBER OF PERSON.

By CONVOY EXTENSION, the dimensions of the vessel are set to the maximum rectangular size of the convoy when operating in inland AIS mode.

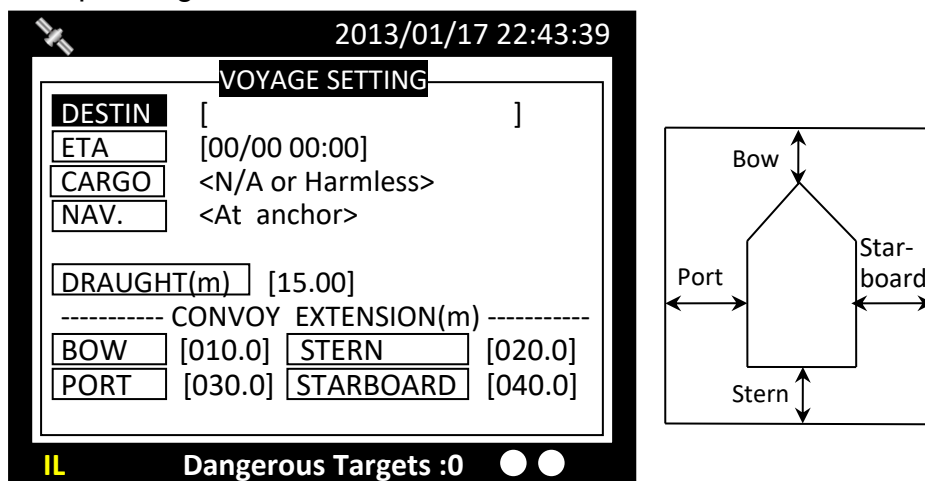

**Figure 59 Inland Voyage Setting**

### 4.8.3 CPA/TCPA

In this submenu the closest point of approach (**CPA**) and time to CPA (**TCPA**) can be set. The vessels with insufficient CPA and TCPA will be displayed in the dangerous list (see 4.7.8) and on coastal and radar view.

- CPA – in nautical miles
- TCPA – in minutes
- Alarm – when alarm is connected to the transponder via junction box, you can choose whether alarm should be activated when a dangerous target appears.

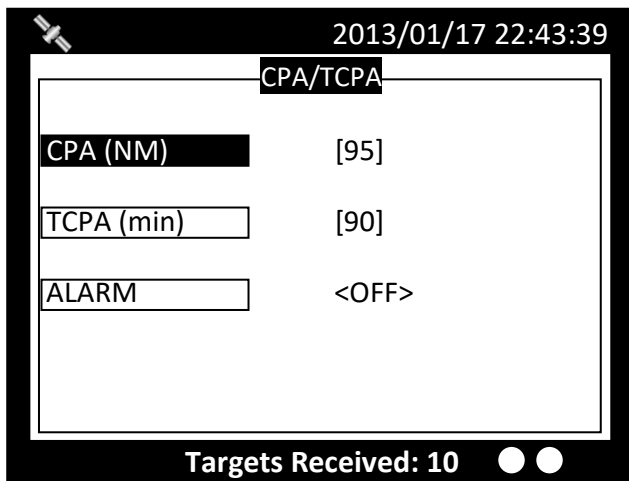
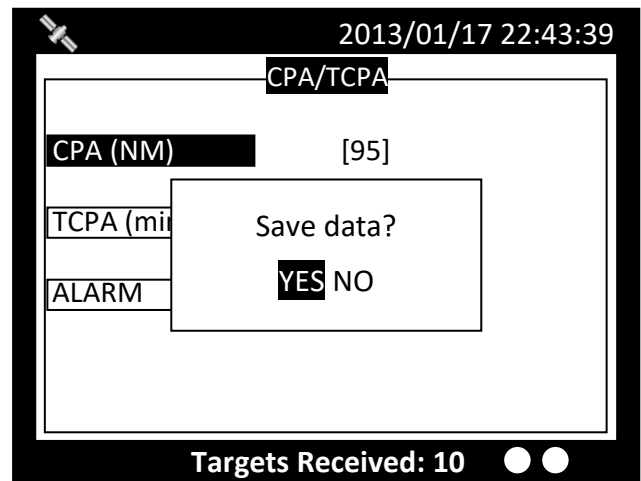

Figure 60



CPA/TCPA

To save the settings, press **MENU** or **ESC** and the system will ask whether the changes should be saved. Select OK to save or CANCEL to discard and return to main menu.

### 4.8.4 Extended Tow Dimension Values

It is beneficial to navigation safety for the true dimensions of vessels to be available via AIS Message 5. Currently, the ABCD values in Message 5 are difficult to change once set, requiring a password that may not be available to the vessel navigator.

This is not a problem for most vessels, except those engaged in towing operations by pushing ahead or alongside (navigational status is 12). In these instances, it may be desirable to provide easier access to and modification of vessel dimension values.

When navigational status is 12. User can set extended tow dimension values in this page.

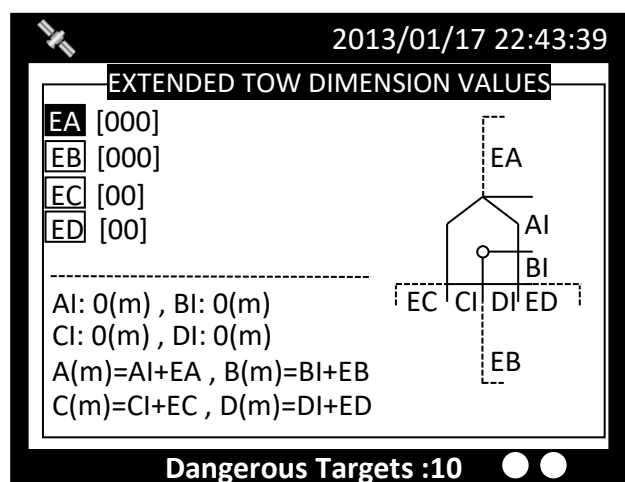

Figure 61

Extended tow dimension values

## 4.8.5 SET MMSI/IMO/ENI

This section is password protected and can only be accessed using the password (see 4.11.6).

### 4.8.5.1 SOLAS Mode

This submenu provides access to set **MMSI** and **IMO**. Use the knob to choose the menu option either MMSI or IMO.

This function is for installation only

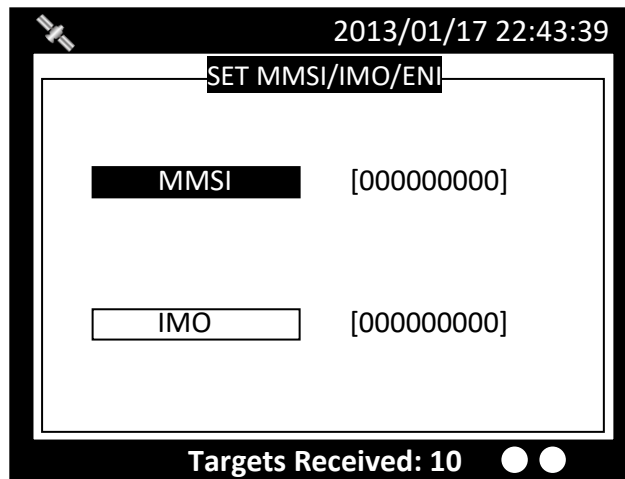

Figure 62 Set MMSI/IMO/ENI

For SOLAS vessels, the MMSI number can be entered in a valid range which is indicated on the input screen. To save the settings, press **MENU** or **ESC** and the system will ask whether the changes should be saved. Select OK to save or CANCEL to discard and return to main menu.

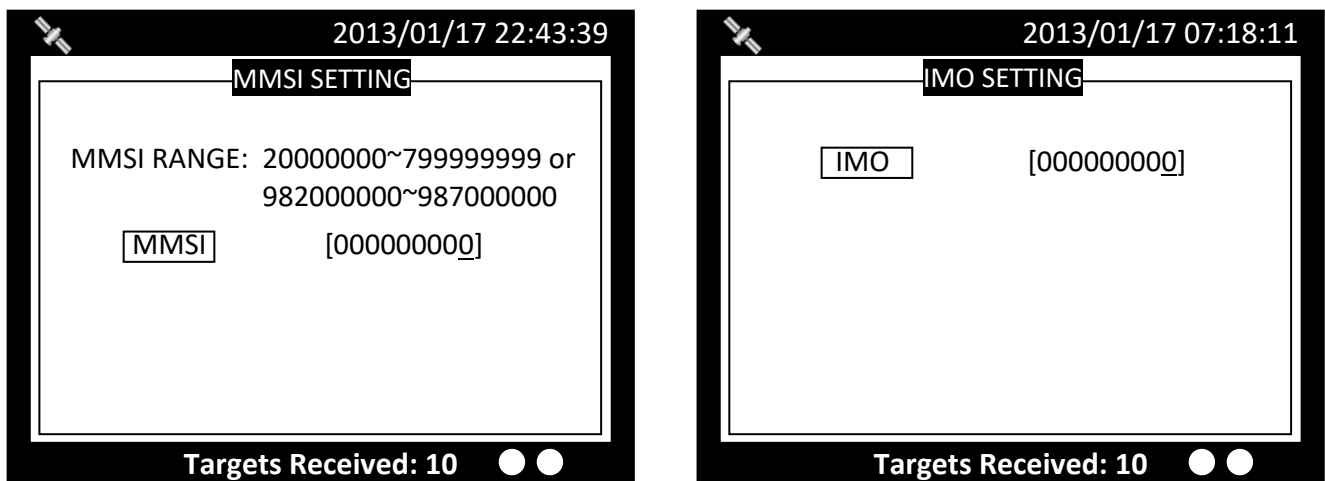

Figure 63 MMSI/IMO Setting

### 4.8.5.2 Inland Mode

The ENI (unique European Vessel Identification Number) setting is only available under inland mode, while IMO setting is not accessible in this mode. The procedure to set/change MMSI number is same as described in 4.8.4.1.

This function is for installation only

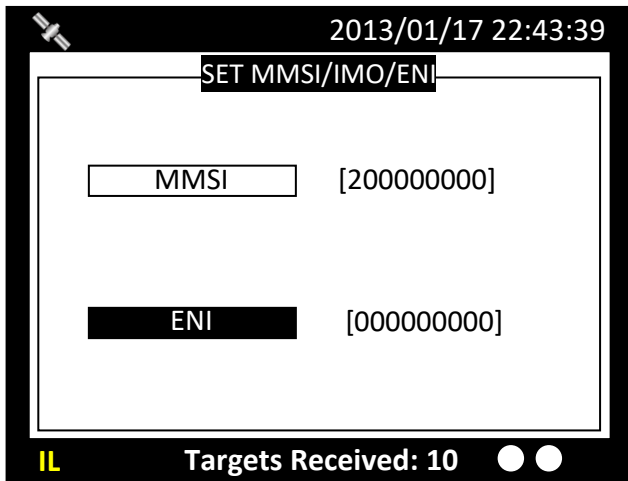
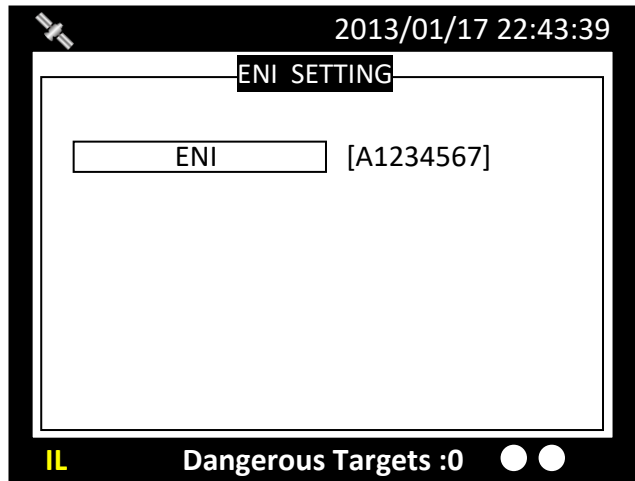

Figure 64



ENI Setting

When setting is done, press ESC to exit.

#### 4.8.6 Retry Times

In order to resend messages when the transmitted Message 6 or Message 12 receives no acknowledgement of Message 7 or Message 13, you can set how many times you want the system to resend messages. The options are 0 (no repeat), 1 (repeat one time), 2 (repeat 2 times) or 3 (repeat 3 times).

#### 4.8.7 AIS Mode

Here you can configure the transponder to operate in SOLAS or INLAND mode. Each mode has some specific submenu and menu options.

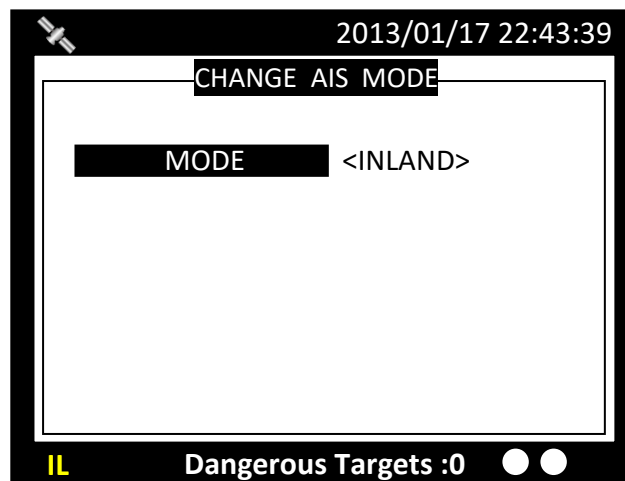

Figure 65

Switching between SOLAS and Inland modes

### 4.9 Inland Setting

All boat information inland setting can be found under this menu.



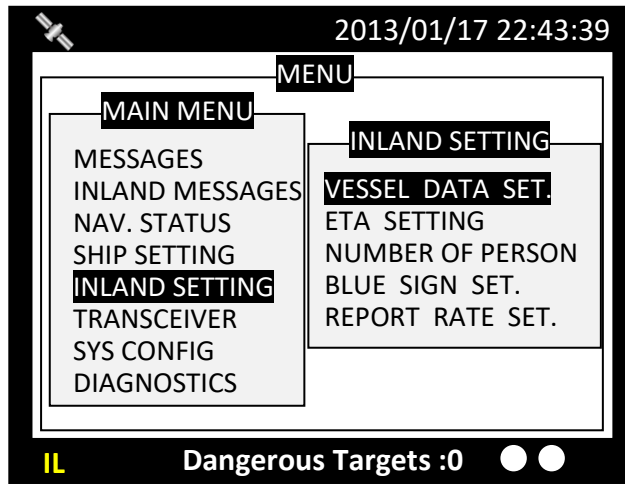

Figure 66 Submenus under Inland Setting

## 4.9.1 Vessel Data Setting

Inland related vessel data can be set in this submenu:

- ERI Ship Type – ERI classification code.
- Blue Cones - The number of blue cones or blue flag status for the cargo (1, 2 or 3 blue cones, or blue flag).
- Load Status - 'Loaded', 'Unloaded', 'Unknown'
- Quality of Speed, Course and heading information - will be shown as 'high' when the target vessel is using an approved sensor to generate this data, or low if the data is derived from internal GNSS only.

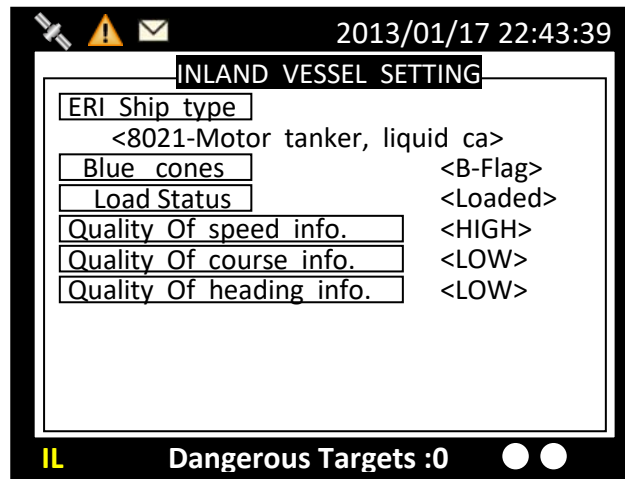

Figure 67 Inland Related Vessel Data

## 4.9.2 ETA Setting

This menu provides ETA (RFM21) related setting:

- UN country and location code - the voyage destination should be entered using UN country (2 characters) and location codes (3 characters) where possible.
- Fairway Number, Terminal Code & Fairway Hectometre: each is limited to 5 characters when available
- ETA - Estimated time / date of arrival at destination using UTC format MMDDHHMM (excluding year)
- Number of Tugboats: The number of assisting tugboats (from 0 to 6 or unknown)
- Air Draught: The air draught of the vessel to the nearest centimetre.

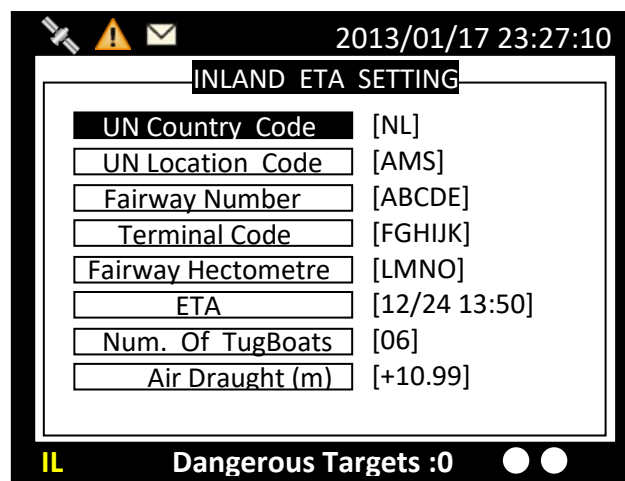

Figure 68 Inland ETA Setting

To save the settings, press **MENU** or **ESC** and the system will ask whether the changes should be saved. Select OK to save or CANCEL to discard and return to main menu.

### 4.9.3 Number of Person

This submenu provides Number of Person (RFM55) setting:  
The number of crew (0 to 254 or unknown), passengers (0 to 8190 or unknown) and other shipboard personnel (0 to 254 or unknown).

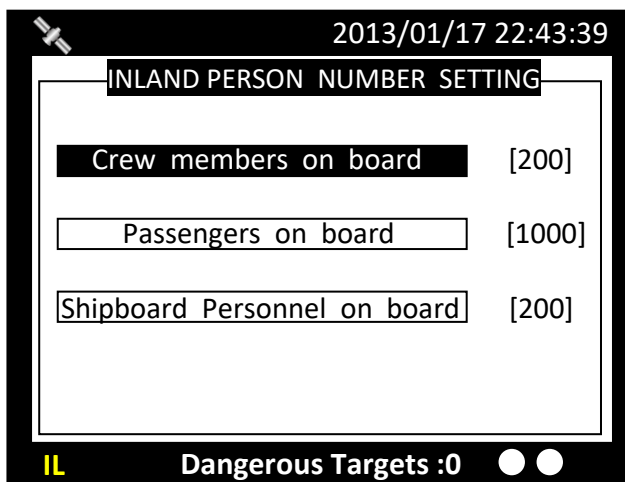

Figure 69 Number of Person Setting

### 4.9.4 Blue Sign Setting

Blue Sign information helps you recognize the approaching vessels in your inland waterway area. A 'blue sign' switch may optionally be connected to the AIS transceiver during installation. This setting enables or disables the blue sign switch on the Junction Box.

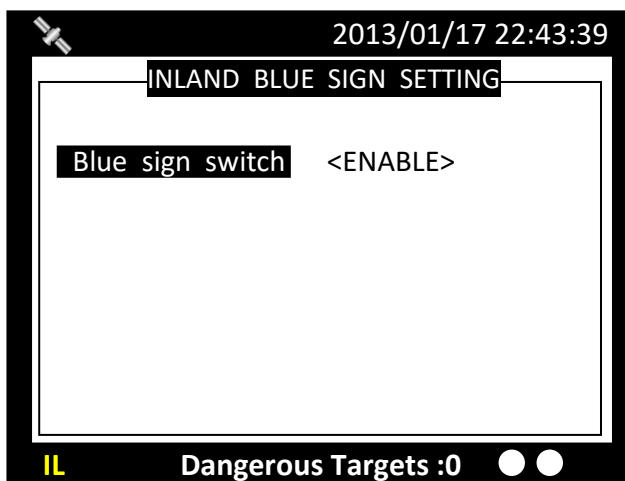

Figure 70 Blue Sign Switch Setting

### 4.9.5 Report Rate Setting

Set M5's report rate. Selectable report rates are AUTO/ 10 SEC./ 5 SEC./ 2 SEC..

## 4.10 Transceiver

The submenu allows the users to switch on or off the transmission, change the supplied voltage of the GPS antenna between 3.3V and 5V, and allows the transmission power to be switched between 12.5W, as "normal", and 1W.

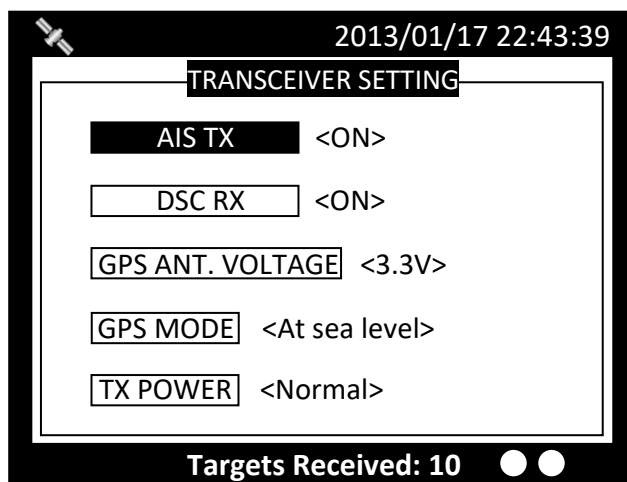

Figure 71 Transceiver

For inland vessels that operate at an altitude higher than 500 meters, the transponder needs the GPS Mode set to "Altitude higher than 500m" for better GPS positioning performance.

To save the settings, press **MENU** or **ESC** and the system will ask whether the changes should be saved. Select OK to save or CANCEL to discard and return to main menu.

## 4.11 Sys Config

System configuration provides access to user configurable preferences for M5. All user settings are stored within the transponder and will be maintained if the power supply is switched off. After the setting is done, press **MENU** or **ESC** and the system will ask whether the changes should be saved. Select OK to save or CANCEL to discard and return to main menu.

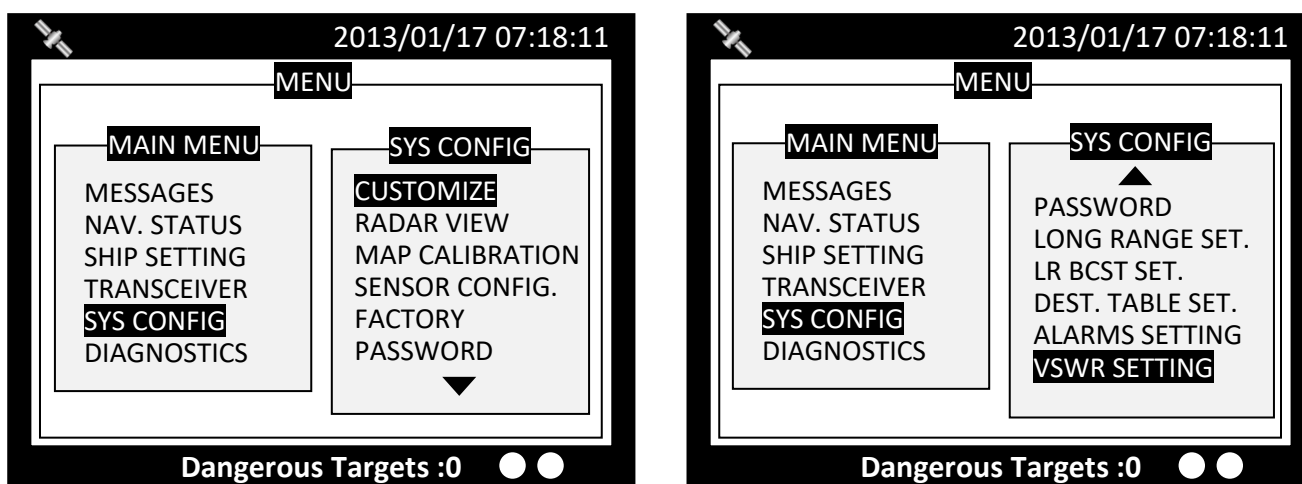

Figure 72 System configuration

### 4.11.1 Customize

Customize provides personalization settings:

- Dimmer Level - brightness setting from 1 (low) to 100 (high)
- Colour mode - brightness and contrast adjustment for the LCD display along with selection of day or night operating mode. In night mode the display colours are inverted (light text on a dark background).
- Key time-out - time to leave menu screen and switch back to coastal view
- Language - available: select the user interface language from the available language options.
- Key Beep – turn on or off the key beep
- Time Zone – set the time zone
- SART test mode – hide or display the SART test message
- NMEA 2000 device instance is used to identify multiple similar products connected on the same NMEA 2000 network. The setting value is between 000 and 252.
- Coordinate Format – user can choose between DD°MM.SS" (degrees, minutes, seconds) and DD°MM.mm' (degrees, minutes, decimal minutes) to display the vessel coordinate.

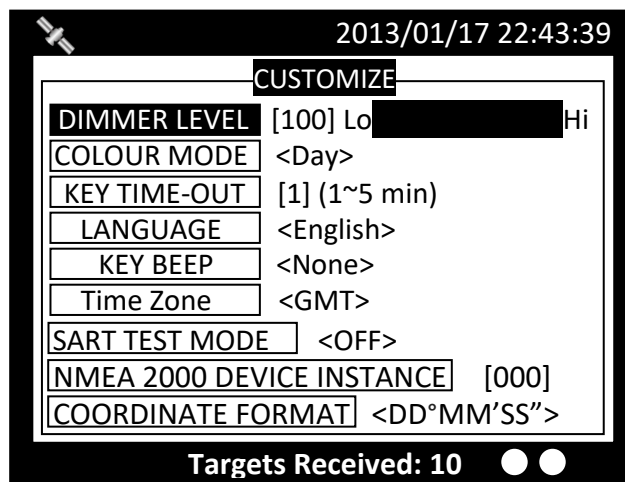

Figure 73 Customize

### 4.11.2 Radar View

This setting provides user the ability to centre the radar map on given coordinates. Turn **knob** to choose either latitude or longitude and press **knob** to confirm. Once pressed, turn **knob** to choose a parameter and press **knob** again to enter input mode. When finished, press **ESC** to return to the level before. Continue these procedures till all settings are set.

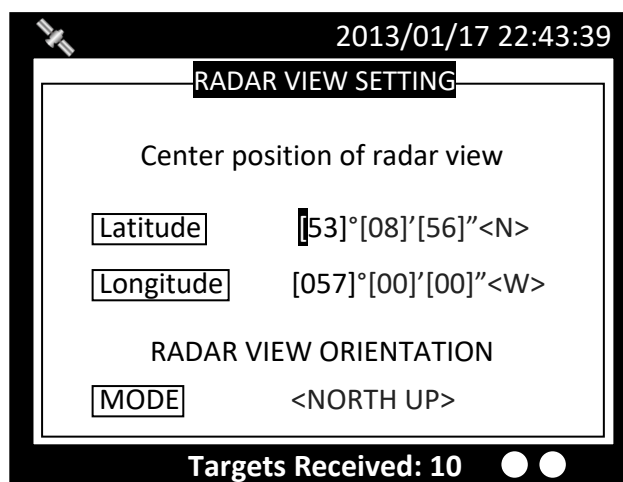

Figure 74 Radar View Setting

RADAR VIEW ORIENTATION has NORTH UP/ COURSE UP / HEAD UP view modes.

### 4.11.3 Map Calibration

This setting offers user functions to calibrate map data. Turn **knob** to select either latitude or longitude to offset. Press **knob** to enter input mode. Turn **knob** to select an offset value. Once finished press **ESC** to return to the previous level to continue the setting.

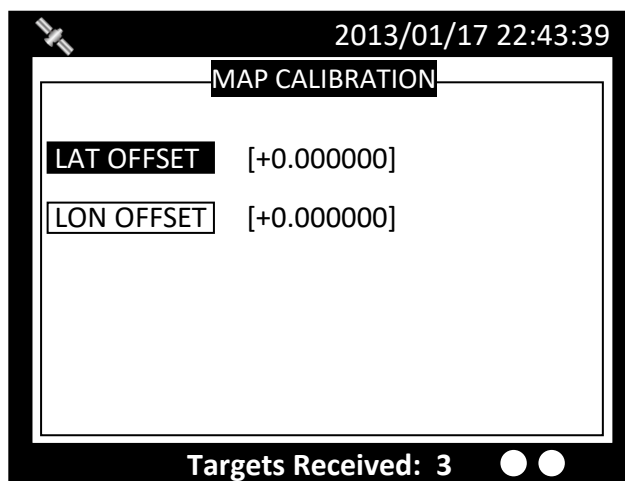

Figure 75 Map Calibration

### 4.11.4 Sensor Config

This section is password protected and can only be accessed using the password (see 4.11.6).

**Sensor Configuration** provides user to set baud rates for sensor ports and USB port. Turn **knob** to select a port to modify and press **knob** to change the specified port baud rate. Turn **knob** to change the desired rate of sensor ports between 4800/9600/19200/38400. USB port can be configured to any baud rate of 4800, 9600, 19200, 38400, 57600 or 115200. Default baud rates of the ports are shown in figure 76 below.

When finished, press **knob** again to return to the previous level.

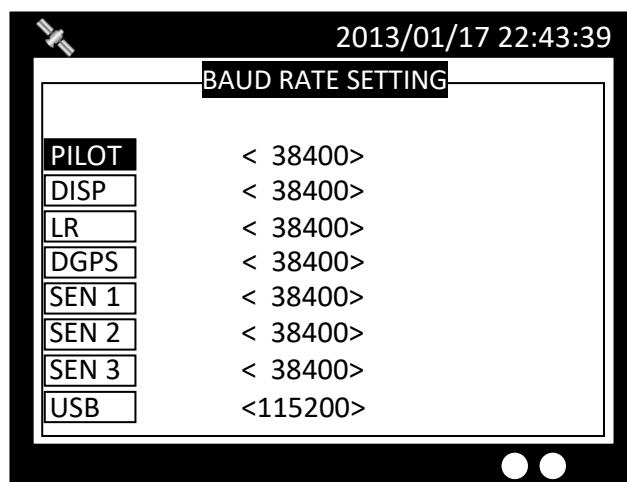

Figure 76 Baud Rate Setting

### 4.11.5 Factory

This section is password protected and can only be accessed using the password (see 4.11.6). Press knob to confirm your choice and the following settings will be restored to their original value: MOB/Friend ship List, destination list, time zone, language, dimmer, CPA/TCPA and system password.

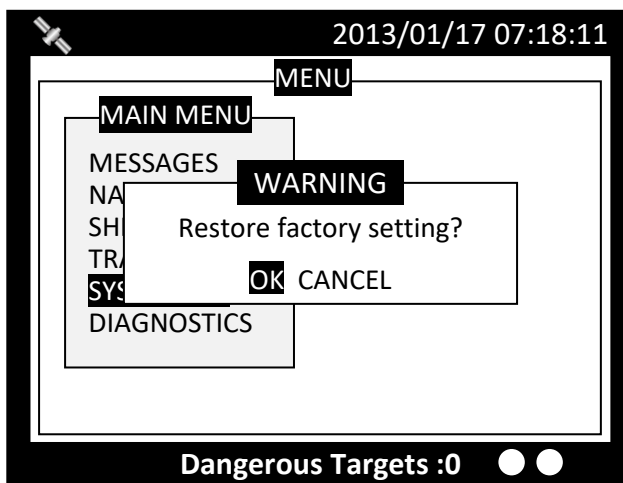

Figure 77 Factory Setting

### 4.11.6 Password

This submenu enables users to change user password. Certain important information stored within the transponder can only be changed with the password. Password is required for the access of the following chapters:

- 4.8.1 Own Ship – contains information about call sign, vessel name and ship type
- 4.8.4 Set MMSI/IMO/ENI – contains information about MMSI and IMO number
- 4.11.4 Sensor Configuration – about baud rate configuration of sensors
- 4.11.5 Factory – restoration of factory setting
- 4.11.10 Alarms Setting
- 4.11.11 VSWR Setting

 (Default password: “0000”) This function is for installation only Use the knob in the order of “**OLD PASSWORD**”, “**NEW PASSWORD**”, “**CONFIRM NEW PASSWORD**”. Repeat till all four values are entered. To save the settings, press **MENU** or **ESC** and the system will ask whether the changes should be saved. Select **OK** to save or **CANCEL** to discard and return to main menu.



Figure 78 Password

### 4.11.7 Long Range Setting

This option provides user choices to auto-response remote interrogation and settings of the response information.

You can either set **MODE** to either **AUTO** or **MANUAL**. The setting for the rest of information is either **SUPPLY** or **REJECT**.

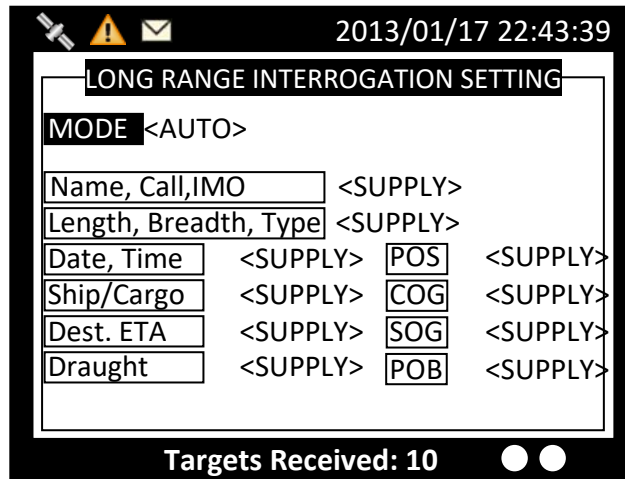

Figure 79 Long Range Setting

### 4.11.8 Long Range Broadcast

Class A transmits Message 27 every 3 minutes through the channels alternately. Provided here are the options to enable or disable Long Range Broadcast and the transmitting channel for Message 27.

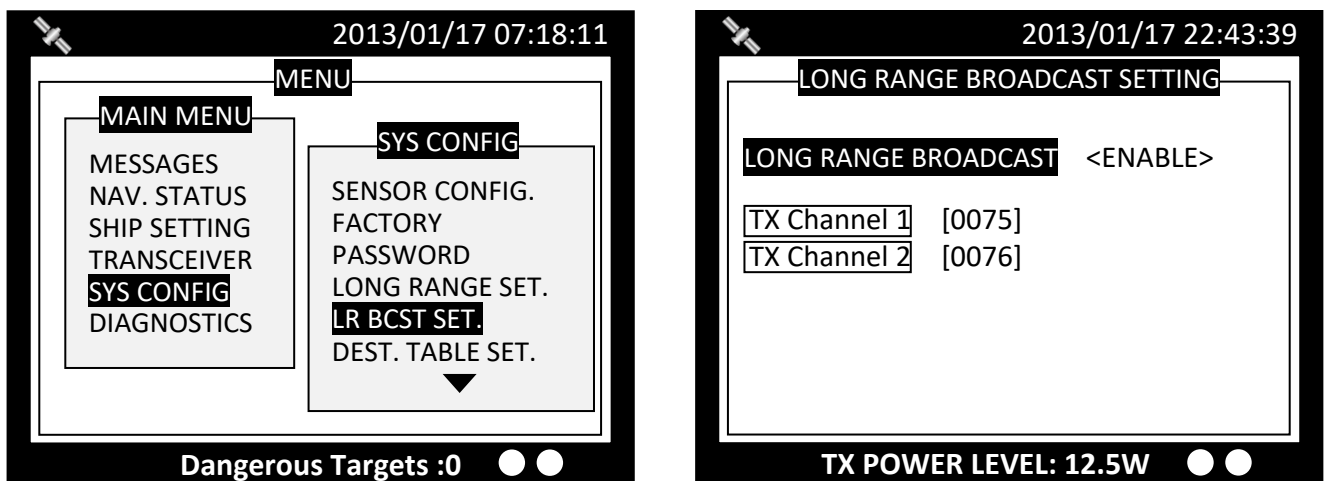

Figure 80 Long Range Broadcast



Only AIS channel numbers can be entered for TX channel. Channel 2078, 2088, and the current channel used in the region cannot be used.



### 4.11.9 Destination Table Setting

Save up to 10 destinations. Use rotary knob to traverse text and to modify. Press Menu to save changes. The Destination Table saves up to 10 frequently used destinations which can be conveniently configured in vessels voyage setting (see 4.8.2.1).

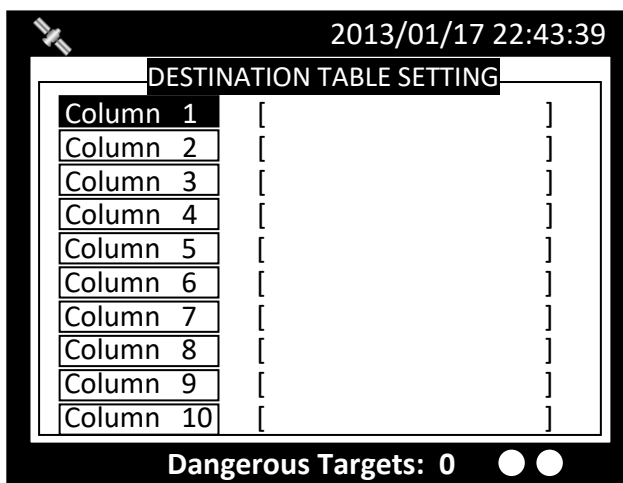

Figure 81 Destination Table Setting

### 4.11.10 Alarms Setting

This menu is password protected. The menu can be used to enable or disable ALR 25/32/35 sentence. For instance, if an ALR sentence is disabled, the corresponding alarm would not activate.

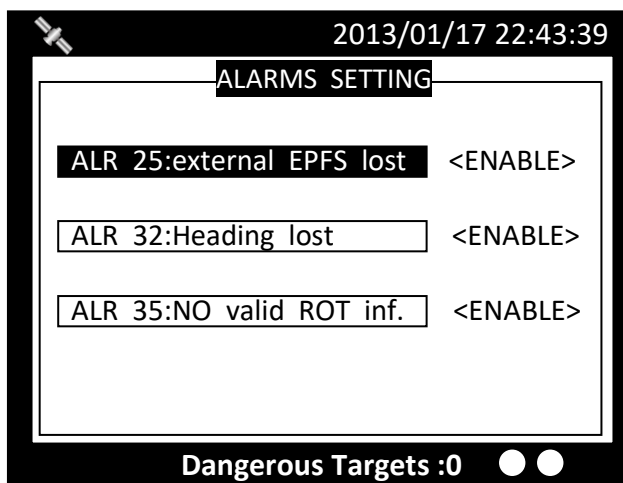

Figure 82 Alarm Setting for ALR 25/32/35

### 4.11.11 VSWR Setting

The VSWR setting function allows the fine-adjustment of the VSWR threshold, to allow for the cable length and VHF antenna characteristics. This function is password protected (see 4.11.6) and should be performed by a qualified service partner or dealer.

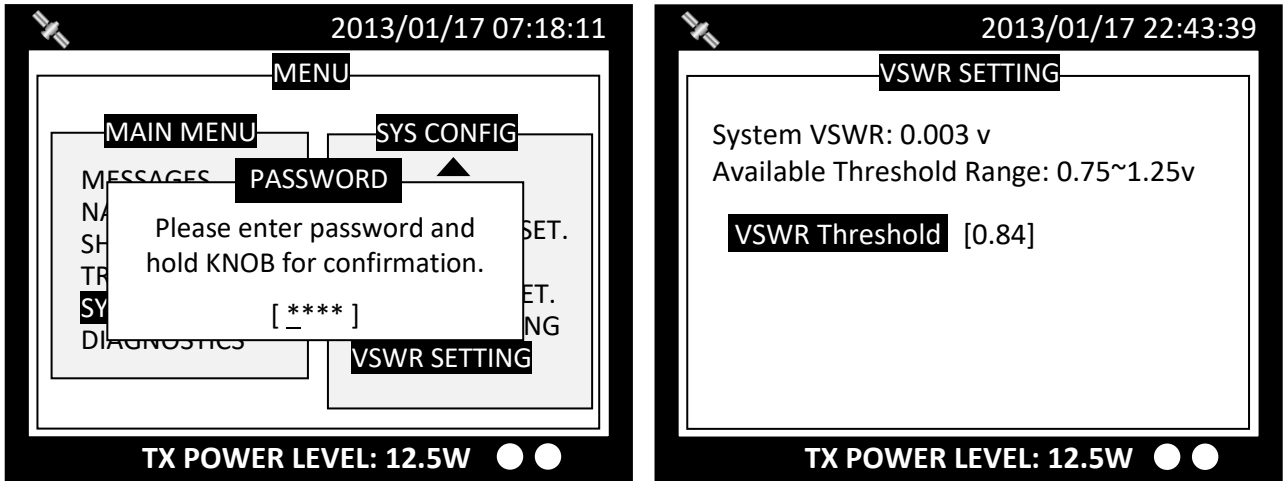
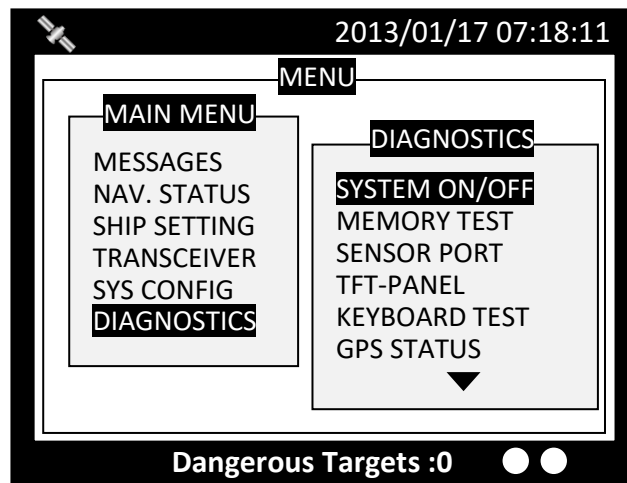

Figure 83 VSWR Setting

## 4.12 Diagnostics

This submenu provides users to check system statuses. There are a total of 8 check options.



**Figure 84** Diagnostic

**System On/Off:** This option provides activation history. (any power-off session less than 15 minutes would not be registered in the history)

**Memory Test:** This option provides memory testing on the unit.

**Sensor Port:** This option provides an overview of baud rates on all ports and status information.

**TFT-Panel:** This option provides colour information on the monitor.

**Keyboard Test:** This option provides keyboard testing. Pressing button during testing, a corresponding button on the screen will response. After all buttons are tested, a message will indicate. Press **knob** for **OK** to exit. To quit test without completing, wait for 30 seconds and the system will return to the main menu.

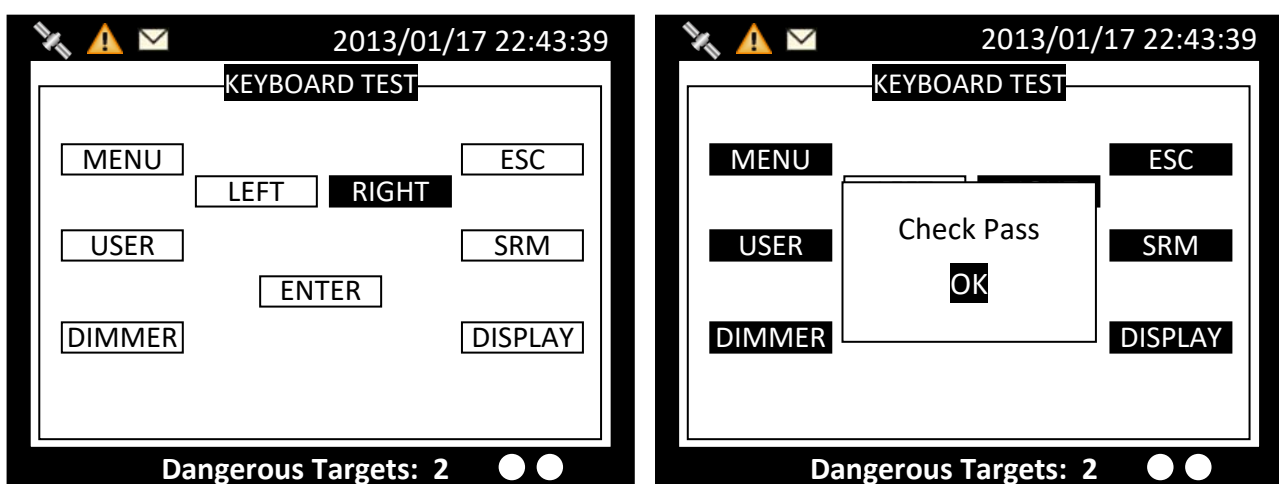

**Figure 85** Keyboard Test

**GPS Status:** This option provides GPS satellite status information. Green indicates satellite being used for GPS fix. Red indicates satellite not being used.

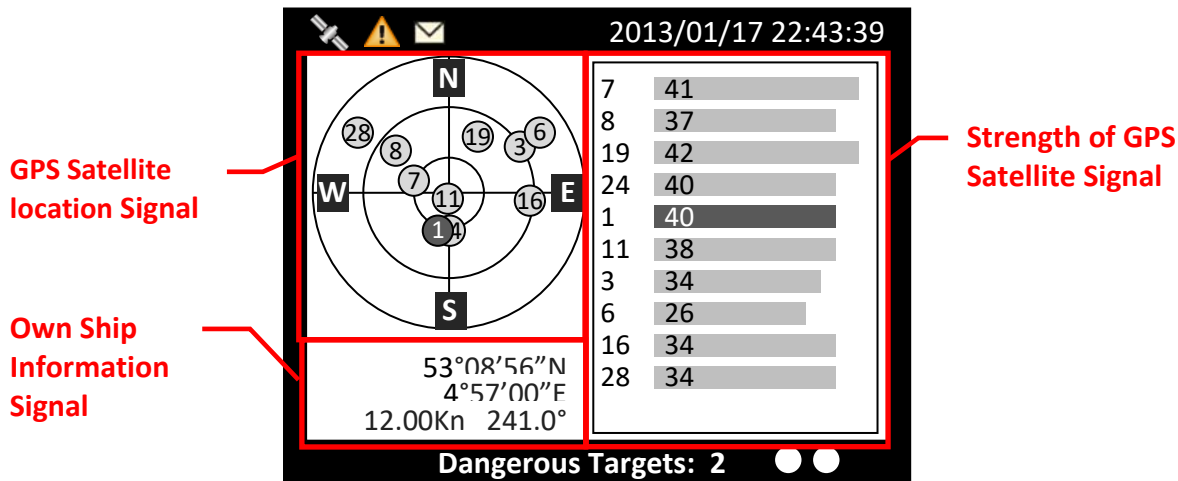

**Figure 86 GPS Status**

**Transceiver:** this option provides user to view the frequencies and status. When finished, press ESC to exit.

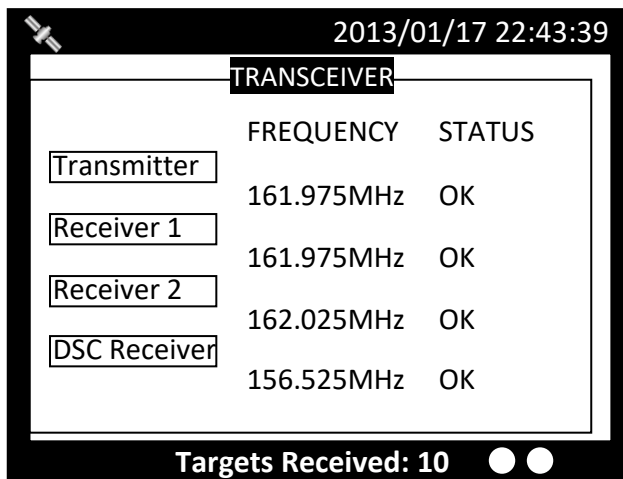

**Figure 87 Transceiver**

**Communication Test:** Communication can be tested. The procedure starts by transmitting Message 10 to an addressed Class A MMSI. The addressee MMSI, once received Message 10, will return Message 11. The test is then complete when the M5 successfully receives the Message 11.

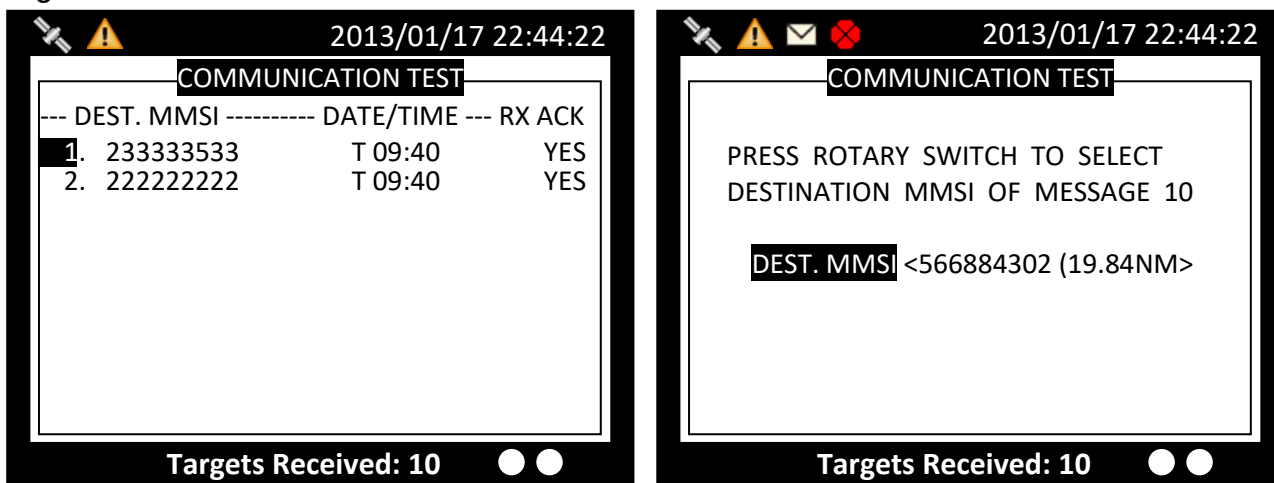

**Figure 88 Communication Test**

Press the **FUNC** button to start the communication test. Following the on-screen instruction by turn the knob to select a class A MMSI number. Then press **MENU**, **ESC** or **FUNC** and click "OK" to

start the transmission of Message 10. Only Class A units with GPS fix are listed and eligible for communication testing. The left screen below indicates no valid Class A targets found.

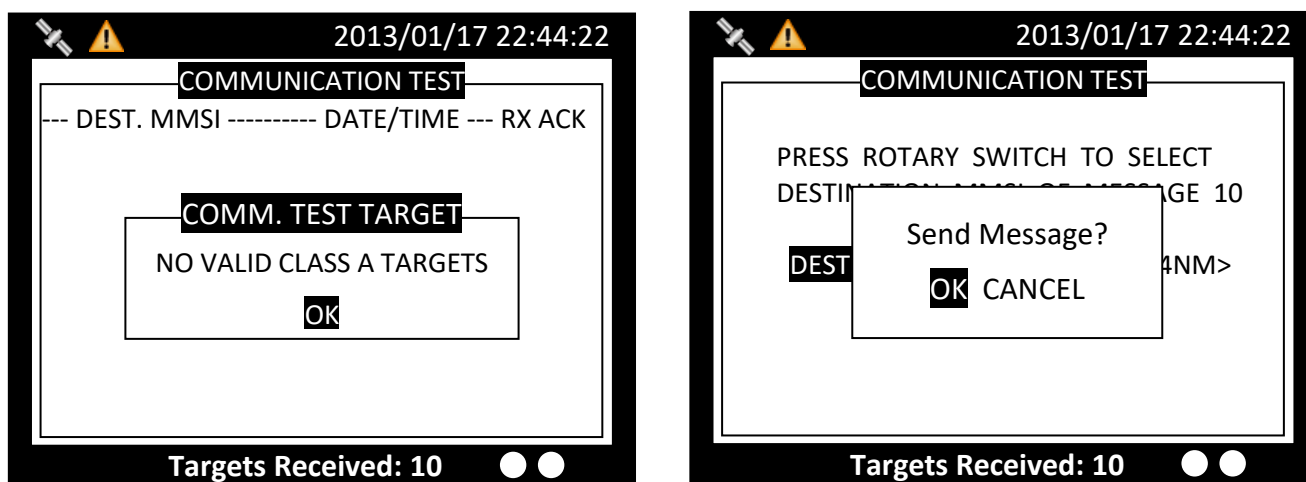

**Figure 89 No Valid Targets**

After pressing the knob, turn the knob to selected destination MMSI for testing. The destination MMSI numbers are the nearest Class A targets found close to the Class A unit. Press ESC or MENU to pick selection and the unit will prompt to confirm message sending. Select OK to proceed testing.

### Panel Test

In the submenu users can test the brightness of the screen. Press “FUNC” to switch the white cube between different sizes. Rotate the scroll wheel quickly to test different stages of brightness. To exit the function, press “MENU” or “ESC”.



**Figure 90 Test with Size and Brightness**

### Version

Provide model name, hardware information, delivered firmware version on the unit, etc. When finished, press ESC to exit.

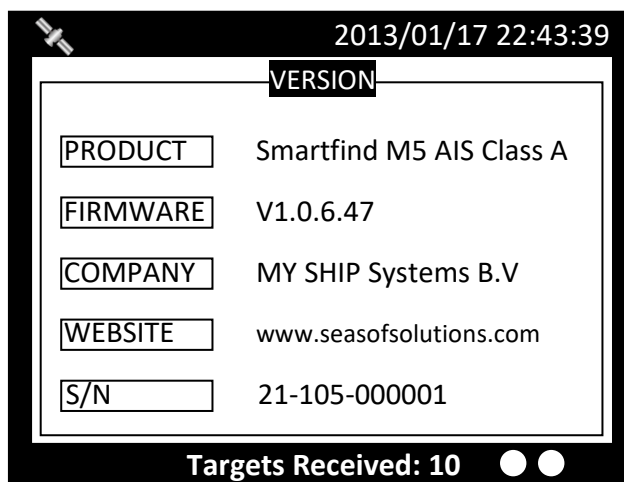

**Figure 91 Version**

## 5 TECHNICAL SPECIFICATIONS

### 5.1 Applicable Standards

IEC 61993-2 Ed.3.0, 2018	IMO Resolution A.694(17)
IEC 61108-1 Ed.2.0, 2003	IMO Resolution MSC.74(69) Annex 3
IEC 60945 Ed.4.0, 2002 incl. Corr. 1, 2008	IMO Resolution MSC.191(79)
IEC 61162-1 Ed.5.0, 2016	ITU-R M.1371-5 (Class A), 2014
IEC 61162-2 Ed.1.0, 1998	ITU-R M.825-3, 1998
IEC 62288 Ed.2.0, 2014	ITU-R M.1084-5, 2012
IEC 62923-1 Ed. 1.0 2018	IEC 62923-2 Ed. 1 2018

### 5.2 VHF Transceiver

Frequency Range	156.025 MHz ~ 162.025 MHz
Channel Bandwidth	25 KHz
Modulation	GMSK / FM
Data Rate	9,600 bps
Number of AIS Transmitter	1
Number of AIS Receiver	2
Number of DSC Receiver	1
AIS Channel 1	CH 87B (161.975 MHz)
AIS Channel 2	CH 88B (162.025 MHz)
Tx Power Output	1/12.5 Watt (30/41 dBm $\pm$ 1.5 dB)
Rx Sensitivity	< -107 dBm @ 20% PER

### 5.3 DSC Receiver

Frequency	156.525 MHz
Modulation	FSK
Channel Bandwidth	25K
Sensitivity	< -107 dBm @ BER < 10 <sup>-2</sup>
Spurious Response Rejection	$\geq$ 70 dB for signal @ -104 dBm; BER $\leq$ 1 %
Blocking	$\geq$ 84 dB for signal @ -104 dBm; BER $\leq$ 1 %

## 5.4 GPS Receiver (Internal)

Receiving Channels	50 channels
Tracking & Navigation Sensitivity	$\geq$ -159 dBm
Reacquisition Sensitivity	$\geq$ -159 dBm
Horizontal Position	< 2.5 m Autonomous < 2.0 m SBAS
Receiver Type	SBAS: WAAS, EGNOS, MSAS, GAGAN

## 5.5 Power Supply

Supply Voltage	12V / 24V DC
Power Consumption	Less than 9W average @ 12V DC; Less than 65W peak power @ 12V DC

## 5.6 LCD Display

Screen Size	3.5" colour TFT
Pixel Number (Resolution)	320 x 240
Viewing Mode	Basic coastline map/ Radar View/ Alphanumeric views /Satellite View
Dimmer Control	Step-less Setting

## 5.7 Keypad & Knob

6 Keypads with Back-light	1 for SRM, 1 for Menu, 1 for Dimmer, 1 for ESC, 1 for Display, 1 for Nav. Status
Knob	Multi-Function

## 5.8 Connection Interface

GPS Antenna Connector	TNC (Female)
VHF Antenna Connector	SO-239 (Female)
Sensor Interfaces 1 to 3	IEC 61162-1 or -2
Pilot / Auxiliary	IEC 61162-2
External Display	IEC 61162-2
Long-range	IEC 61162-2
DGNSS correction input	RTCM-SC-104

Alarm relay	Normally closed
USB	Mini type B USB interface
NMEA2000	IEC61162-3
Alarm Output	Relay contact

## 5.9 Environmental

Operating Conditions	IEC 60945 “protected” category
Operating Temperature	-15°C ~ 55°C
Operating Humidity	95% RH at 40°C
Waterproof	IPX2

## 5.10 Physical

Width	261 mm (10.28 inch)
Height	184 mm (7.25 inch)
Depth (include connectors)	102 mm (4.02 inch)
Weight	≤ 2.5 kg

## 5.11 Pilot Plug

Cable length	2 m
Connector type	Std. Sex 206486-2



## 5.12 NMEA 2000 PGN Information

The following table is a list of the NMEA 2000 messages supported by the Smartfind M5 unit. The “Transmit” PGNs information includes “Own ship” + “Received AIS information from other ships”. This is the reason the NMEA2000 PGN list covers both Class A and Class B related information.

Transmit	
PGN	Description
59392	ISO Acknowledgment
59904	ISO Request
60928	ISO Address Claim
126464	PGN List - Transmit PGN's group function
126996	Product Information
129025	Position Rapid Update
129026	COG SOG Rapid Update
129029	GNSS Position Data
129038	AIS Class A Position Report
129039	AIS Class B Position Report
129040	AIS Class B Extended Position Report
129041	AIS Aids to Navigation (AtoN) Report
129539	GNSS DOPs
129540	GNSS Sats in View
129792	AIS DGNSS Broadcast Binary Message
129793	AIS UTC and Date Report
129794	AIS Class A Static and Voyage Related Data
129795	AIS Addressed Binary Message
129796	AIS Acknowledge
129797	AIS Binary Broadcast Message
129798	AIS SAR Aircraft Position Report
129800	AIS UTC/Date Inquiry
129801	AIS Addressed Safety Related Message
129802	AIS Safety Related Broadcast Message
129803	AIS Interrogation
129804	AIS Assignment Mode Command
129805	AIS Data Link Management Message
129806	AIS Channel Management
129807	AIS Group Assignment
129809	AIS Class B “CS” Static Data Report, Part A
129810	AIS Class B “CS” Static Data Report, Part B
Receive	
PGN	Description
59392	ISO Acknowledgment
59904	ISO Request
60928	ISO Address Claim
127250	Vessel Heading
127258	Magnetic Variation

## 6 MECHANICAL DIMENSIONS

### 6.1 Smartfind M5 Transponder Main Unit

#### Front (size: mm)

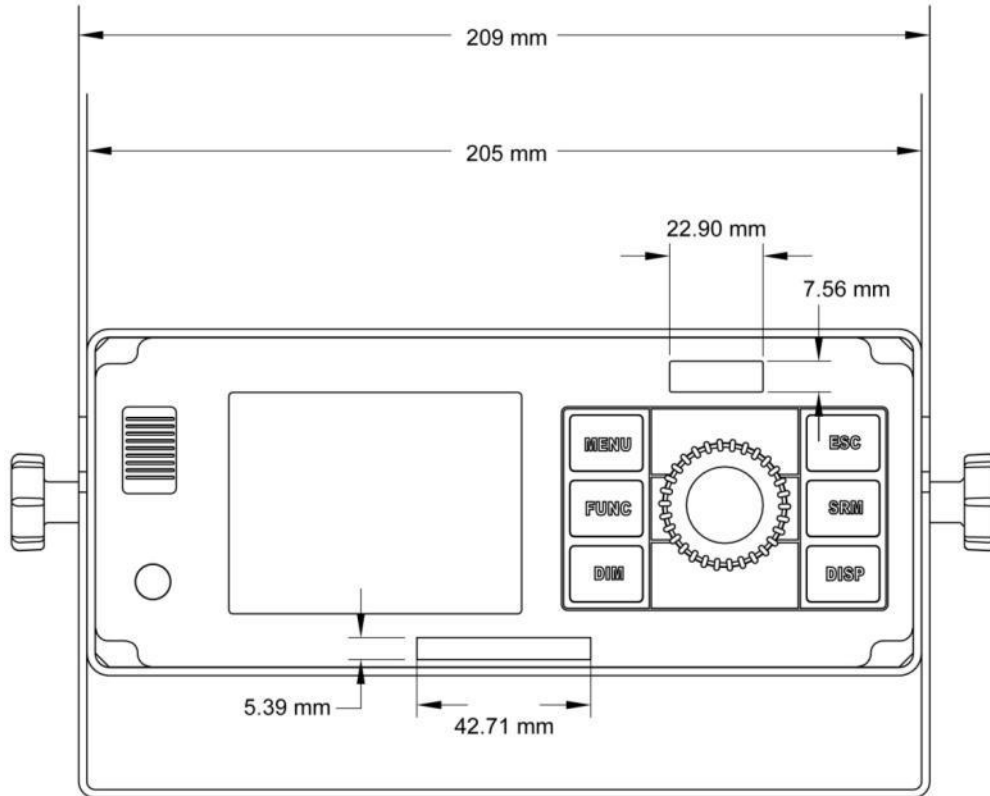

#### Side (size: mm)

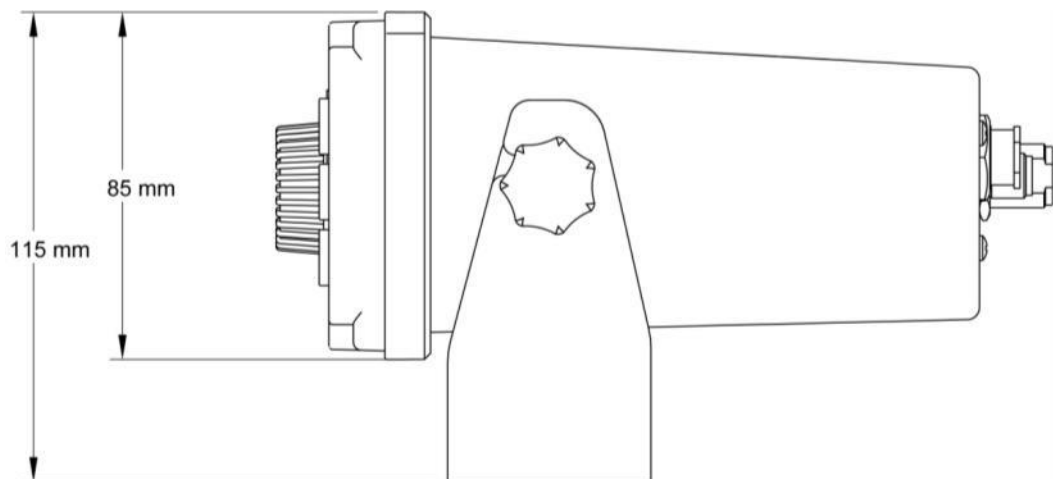

**Back (size: mm)**

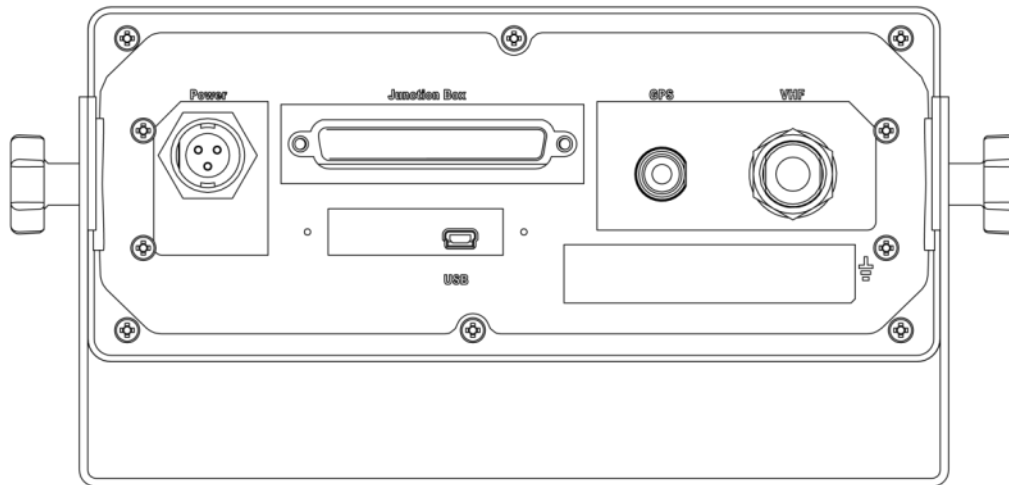

**Bottom (size: mm)**

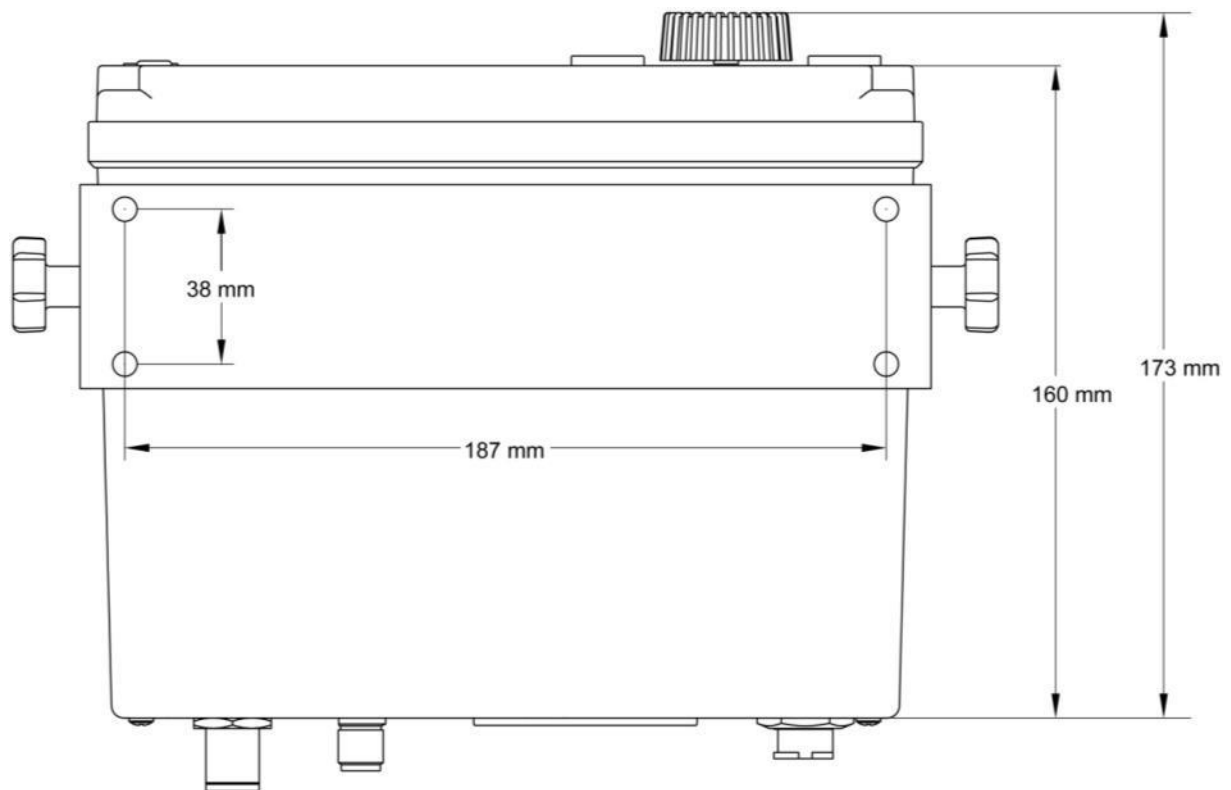

## 6.2 Junction Box

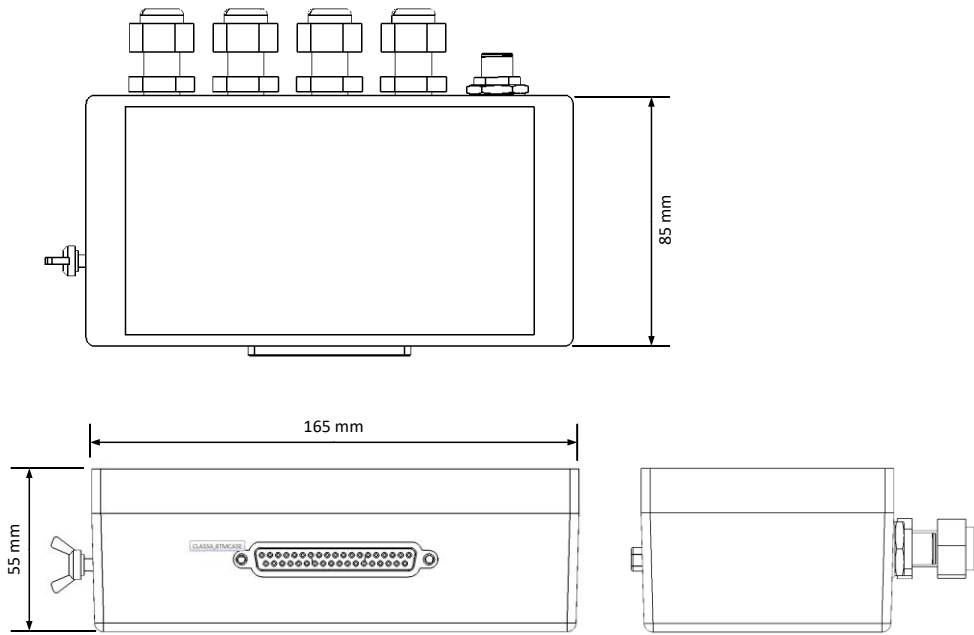

## 6.3 Extension Cable

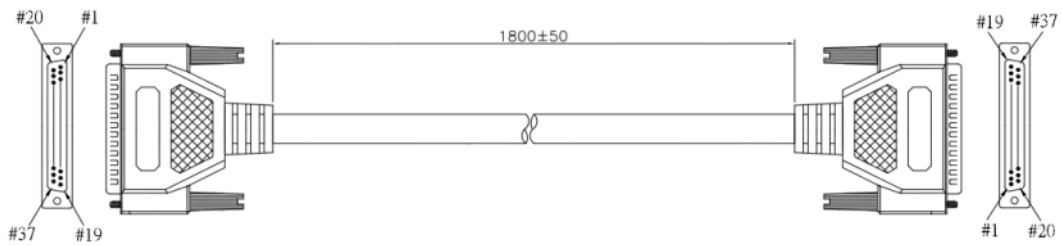

## 6.4 Mounting Template (not to scale)

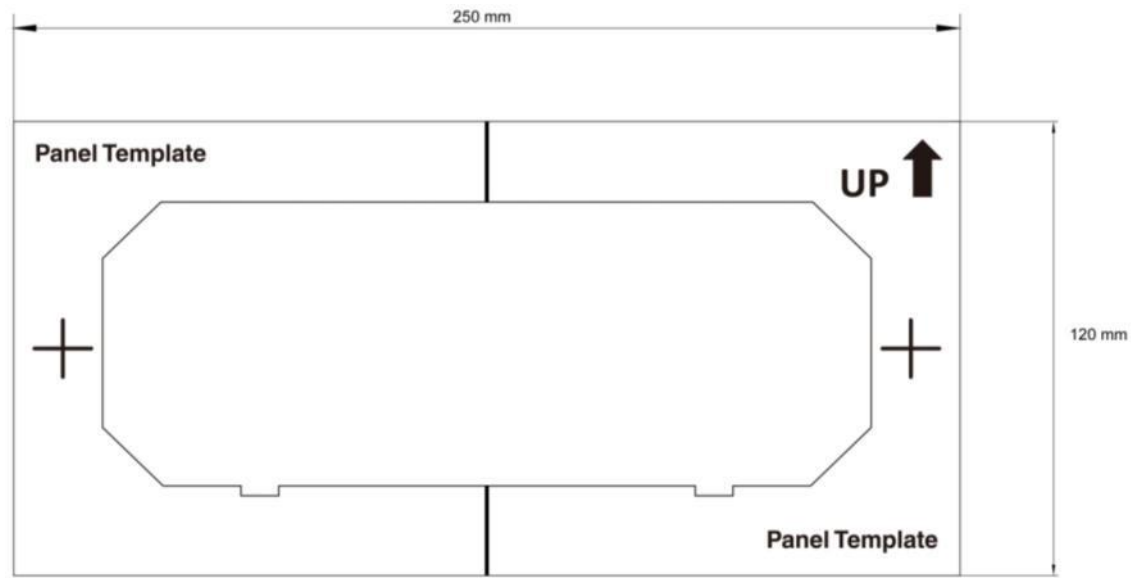

## 6.5 GPS Antenna

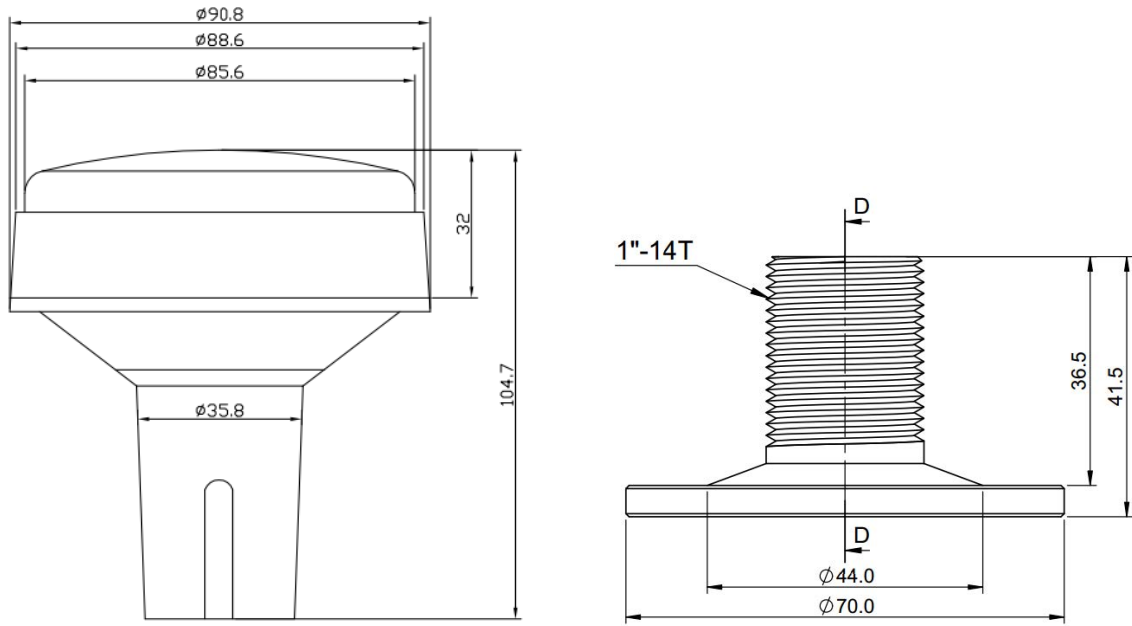

## 6.6 Pilot Plug

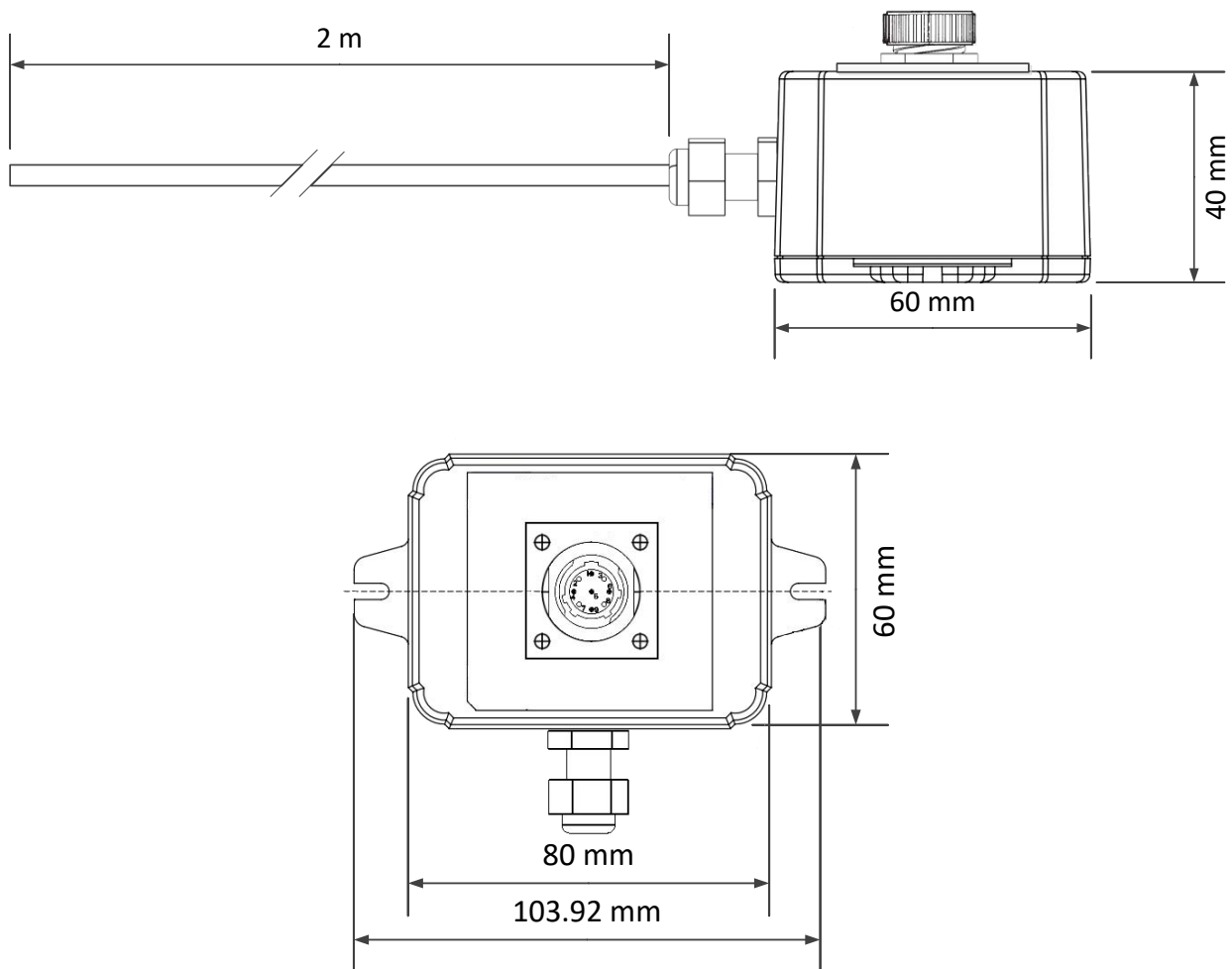

## 7 TROUBLESHOOTING

Use the following guide to perform simple troubleshooting in case the transponder is not function accordingly.

Symptom	Possible Cause	Solution
<b>Transponder cannot power on</b>	Faulty connector to power Polarity reverse Power supply current too low	Check power connection Check power connection Check power supply
<b>No picture on display</b>	Unit not powered up Dimmer level set too low	Press power key Increase Dimmer level
<b>No map detail</b>	Coastline detail not active	Switch to coastline view
<b>No GPS position data</b>	Antenna or cabling problem	Check antenna cable and connections
<b>No AIS transmission</b>	MMSI not entered Transmitter disabled Power supply voltage too low	Enter MMSI number Enable transmitter Check power supply
<b>No AIS target</b>	VHF cabling problem	Check antenna cable and connections
<b>AIS range seems too low</b>	VHF antenna and cabling	Check VHF antenna and cable installation
<b>Sensor ports not response</b>	Cable installation	Check related wiring
<b>Data port not response</b>	Cable installation	Check related wiring

## 8 ABBREVIATIONS

Terms of abbreviations:

<b>ACK</b>	Acknowledgement	<b>AtoN</b>	Aid to Navigation
<b>AIS</b>	Automatic Identification System	<b>AUTO</b>	Automatic
<b>ALR</b>	Alarm	<b>AUX</b>	Auxiliary
<b>ANT</b>	Antenna		
<b>BIIT</b>	Built-In Integrity Test	<b>BRG</b>	Bearing
<b>CH</b>	Channel	<b>CPA</b>	Closest Point of Approach
<b>COG</b>	Course Over Ground		
<b>DEST/DESTN</b>	Destination	<b>DISP</b>	Display
<b>DISP</b>	Display	<b>DIST</b>	Distance
<b>DGNSS</b>	Differential GNSS	<b>DSC</b>	Digital Selective Calling
<b>DGPS</b>	Differential GPS	<b>DTE</b>	Data Terminal Equipment
<b>ECDIS</b>	Electronic Chart Display and Information System	<b>EPIRB</b>	Electronic Position Indicating Radio Beacon
<b>ECS</b>	Electronic Chart System	<b>ESC</b>	Escape
<b>EGNOS</b>	European Geo-stationary Navigational Overlay System	<b>ETA</b>	Estimated Time of Arrival
<b>ENC</b>	Electronic Navigation Chart	<b>EXT</b>	External
<b>EPFS</b>	Electronic Position Fixing System		
<b>FCC</b>	Federal Communications Commission	<b>FSK</b>	Frequency Shift Keying
<b>FM</b>	Frequency Modulation	<b>FUNC</b>	Function
<b>GAGAN</b>	GPS-aided geo-augmented navigation	<b>GND</b>	Ground
<b>GLONASS</b>	Global Orbiting Navigation and Safety System	<b>GNSS</b>	Global Navigation Satellite System
<b>GMDSS</b>	Global Maritime Distress and Safety System	<b>GPS</b>	Global Positioning System
<b>GMSK</b>	Gaussian Minimum Shift Keying	<b>GYRO</b>	Gyro Compass
<b>HDG</b>	Heading		
<b>IALA</b>	International Association of Lighthouse Authorities	<b>IMO</b>	International Maritime Organisation
<b>I/O</b>	Input/Output	<b>IN</b>	Input
<b>ID</b>	Identification	<b>INFO</b>	Information
<b>IEC</b>	International Electrotechnical Commission	<b>ITU-R</b>	International Telecommunications Union - Radio
<b>KN</b>	Knots		
<b>LAT</b>	Latitude	<b>LON</b>	Longitude
<b>LCD</b>	Liquid Crystal Display	<b>LR</b>	Long Range
<b>MED</b>	Maritime Equipment Directive	<b>MMSI</b>	Maritime Mobile Service Identity
<b>Min</b>	Minute	<b>MOB</b>	Man Overboard

<b>MKD</b>	Minimum Keyboard and Display	<b>MSAS</b>	Multi-functional Satellite Augmentation System
<b>NAV</b>	Navigation	<b>NMEA</b>	National Marine Electronics Association
<b>NM</b>	Nautical Mile		
<b>OUT</b>	Output		
<b>PI</b>	Presentation Interface		
<b>RAIM</b>	Receiver Autonomous Integrity Monitoring	<b>ROT</b>	Rate of Turn
<b>RH</b>	Relative Humidity	<b>RTCM</b>	Radio Technical Commission for Maritime services
<b>RNG</b>	Range	<b>Rx</b>	Receive / Receiver
<b>S</b>	Second	<b>SOG</b>	Speed Over Ground
<b>SART</b>	Search and Rescue Transponder	<b>SOLAS</b>	Safety of Life at Sea
<b>SAR</b>	Search and Rescue	<b>SRM</b>	Safety Related Message
<b>SBAS</b>	Satellite Based Augmentation System	<b>SYS</b>	System
<b>TCPA</b>	Time to Closest Point of Approach	<b>Tx</b>	Transmit
<b>TDMA</b>	Time Division Multiple Access	<b>Tx / Rx</b>	Transmit / Receive
<b>UHF</b>	Ultra High Frequency	<b>UTC</b>	Universal Time Co-ordinate
<b>USB</b>	Universal Serial Bus		
<b>VDL</b>	VHF Data Link	<b>VSWR</b>	Voltage Standing Wave Ratio
<b>VHF</b>	Very High Frequency		
<b>WAAS</b>	Wide Area Augmentation System		



# 9 WARRANTY STATEMENT



McMurdo Ltd.

Holbrook Court, E1 Cumberland  
Business Centre, Northumberland  
Road, Southsea, Hampshire,  
PO5 1DS, United Kingdom  
Phone: +44 (0) 2392 623900  
[www.seasofsolutions.com](http://www.seasofsolutions.com)

## SCHEDULE OF PRODUCT WARRANTY (MCMURDO LTD)

### Warranty Registration

Congratulations on purchasing your beacon. As standard, your unit has a one year (12 months) warranty from the date of purchase shown on your invoice, however, this can be extended by registering your unit on-line within 90 days of purchase at: <https://www.seasofsolutions.com> then follow the CONTACT US link at the top of the page to REGISTER WARRANTY.

### Warranty Statement

Subject to the provisions set out below McMurdo Limited warrants that this product will be free of defects in materials and workmanship for a period of one year, for AIS products upon registration through the McMurdo Ltd warranty form, up to two years and for EPIRB and PLB upon registration through the McMurdo Ltd warranty form, up to five years (see above) from the date of purchase.

Exclusions, McMurdo will not be liable to the buyer under the above warranty:

- For any defect arising from fair wear and tear, wilful damage, negligence, abnormal working conditions, failure to follow McMurdo's instructions (whether oral or in writing) including a failure to install properly and/or to use batteries recommended and/or supplied by McMurdo, misuse or alterations or repair of the product by persons other than McMurdo or an Approved Service Agent.
- For parts, materials or equipment not manufactured by McMurdo in respect of which the buyer shall only be entitled to the benefit of any warranty or guarantee given by the manufacturer to McMurdo. For the battery storage life which is specifically excluded from this warranty.
- If the total price for the product has not been paid.
- Warranty is not transferable.
- Batteries.

**THE LIMITED WARRANTY STATED ABOVE IS EXCLUSIVE AND IN LIEU OF ANY OTHER WARRANTY, EXPRESS OR IMPLIED, INCLUDING BUT NOT LIMITED TO ANY IMPLIED WARRANTY OF MERCHANTABILITY OR FITNESS FOR A PARTICULAR PURPOSE.**

McMurdo will not be liable for indirect, special, incidental or consequential damages of any kind sustained from any cause. In no event shall McMurdo be liable for any breach of warranty or other claim in an amount exceeding the purchase price of the product. This warranty does not affect any statutory rights of the consumer. In order to be valid, claims must be made under the above warranty in writing as soon as practicable after discovery of the defect or failure and within the warranty period referred to above. Proof of purchase will be required. The claim should be sent together with the product in question to the address set out below or to an Approved Service Agent. Following a valid warranty claim McMurdo shall be entitled to repair or replace the product (or part) in question free of charge, or at McMurdo's sole discretion to refund to the buyer the price of the product (or a proportional part of the price). McMurdo shall not be liable to a buyer who is not a consumer for any other loss or damage (whether indirect, special or consequential loss of profit or otherwise) costs, expenses or other claims for compensation which arise out of or in connection with this product. In the case of a consumer, McMurdo shall only be liable where other loss or damage is foreseeable. Nothing shall limit McMurdo's liability for death or personal injury caused by its negligence. This warranty is to be interpreted under English law.

**All enquiries relating to this warranty or Approved Service Agents should be sent to McMurdo Ltd**

Phone: +44 (0)23 9262 3900

Email: [sales@seasofsolutions.com](mailto:sales@seasofsolutions.com)

Website: [www.seasofsolutions.com](http://www.seasofsolutions.com)

Registered in England No. 06952856

Registered Office: Holbrook Court, E1 Cumberland Business Centre, Northumberland Road, Southsea, Hampshire, PO5 1DS, UK.

VAT No. GB 980 2079 17

All transactions are subject to our General Terms and Conditions available at [www.seasofsolutions.com/terms](http://www.seasofsolutions.com/terms)

# APPENDIX (A)

## A.1 IEC 61162-2 Data Interface

The Smartfind M5 Class A AIS Transponder provides 2 types of IEC 61162-2 data interfaces for user applications. The first interface type includes 3 input-only sensor data ports and the second interface type includes 4 bidirectional input/output ports. Data port for each interface type will be described in the following section below.

### A.1.1 Sensor Data Input Ports

The schematic of input-only sensor data port is shown in Figure A1. The schematic includes a standard V.11 transceiver IC (Texas Instruments SN65176B) combined with high speed photocoupler which are used as the main components to receive external data. The transceiver IC is isolated from external input. To avoid signal reflection, the transceiver IC has an optional built-in 120Ω loop termination, which is selectable by the dip-switch on the junction box and the switch should be set to on position when connecting external data source with long cable. All sensor data-input ports are isolated from one another and are also isolated from internal power supply. The input impedance on A/B wires is greater than 12 KΩ and the levels on the A/B wires are defined in the following:

- Logic low input:  $A-B < -0.2V$
- Logic high input:  $A-B > +0.2V$

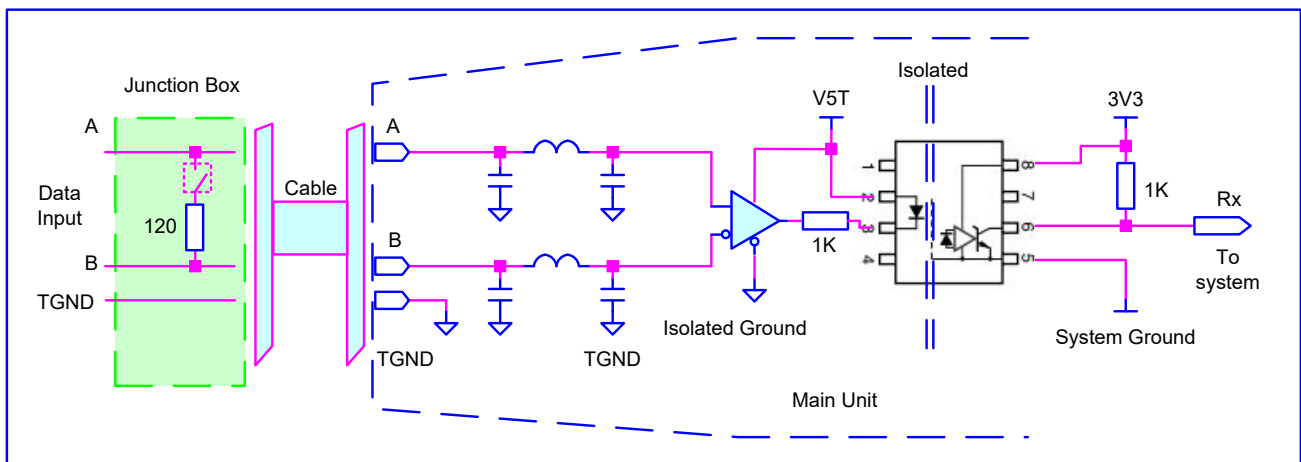
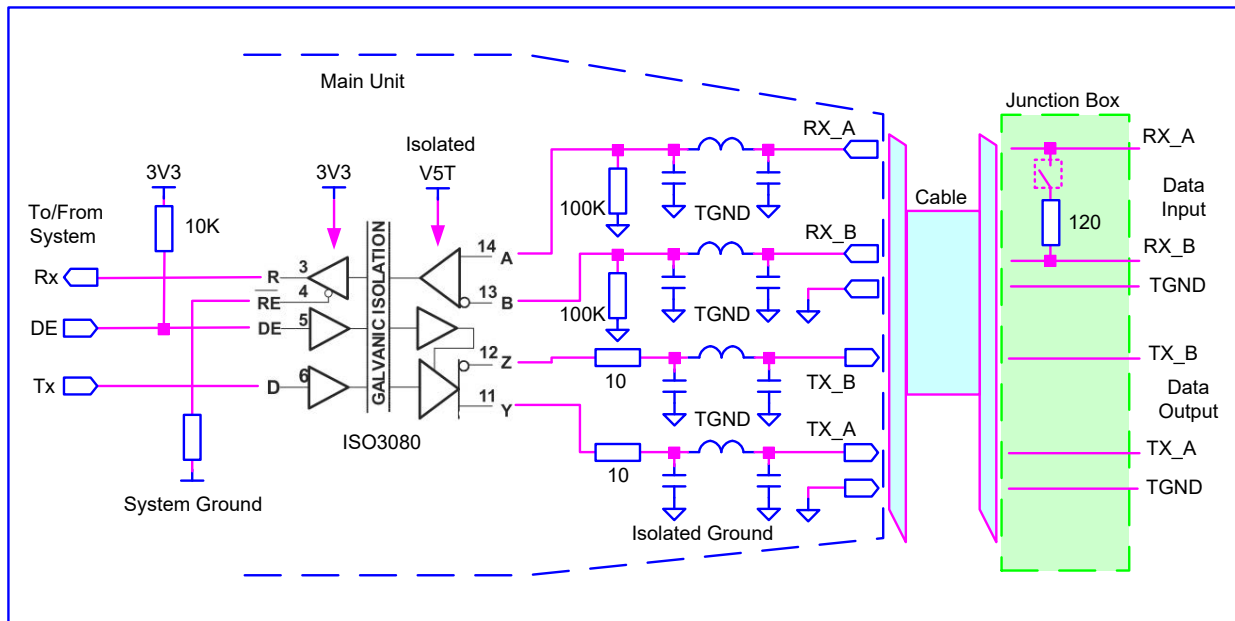

Figure A1 Schematic of sensor data input port.

### A.1.2 Bidirectional Data Ports

The schematic of bidirectional data port is shown in Figure A2. The schematic includes an isolated full duplex RS-485 transceiver IC (Texas Instrument ISO3080) which is used as the main component to handle both data input and output from external data source. The transceiver IC is isolated from external input. To avoid signal reflection, the transceiver IC has an optional built-in 120Ω loop termination, which is selectable by the dip-switch on the junction box and the switch should be set to on position when connecting external data source with long cable. All bidirectional data ports are isolated from one another and are also isolated from internal power supply. The transceiver internal power supply is fully isolated from the external power supply.



**Figure A2 Schematic of bidirectional data port.**

The output driver capability of bidirectional data port can provide a maximum of 60mA, and the minimum differential output swing under 100 Ω load can be 2.3V.

### A.1.3 A and B Signal Lines

Refer to sections A.1.1 and A.1.2.

### A.1.4 Output Driver

The output driver capability of bi-direction data port can provide maximum 60mA, and the minimum differential output swing under 100 ohm load can be 2.3V.

### A.1.5 Input Load

Refer to sections A.1.1 and A.1.2.

### A.1.6 Hardware Input/Output Circuit

Refer to sections A.1.1 and A.1.2.

## A.2 Presentation Interface of Smartfind M5

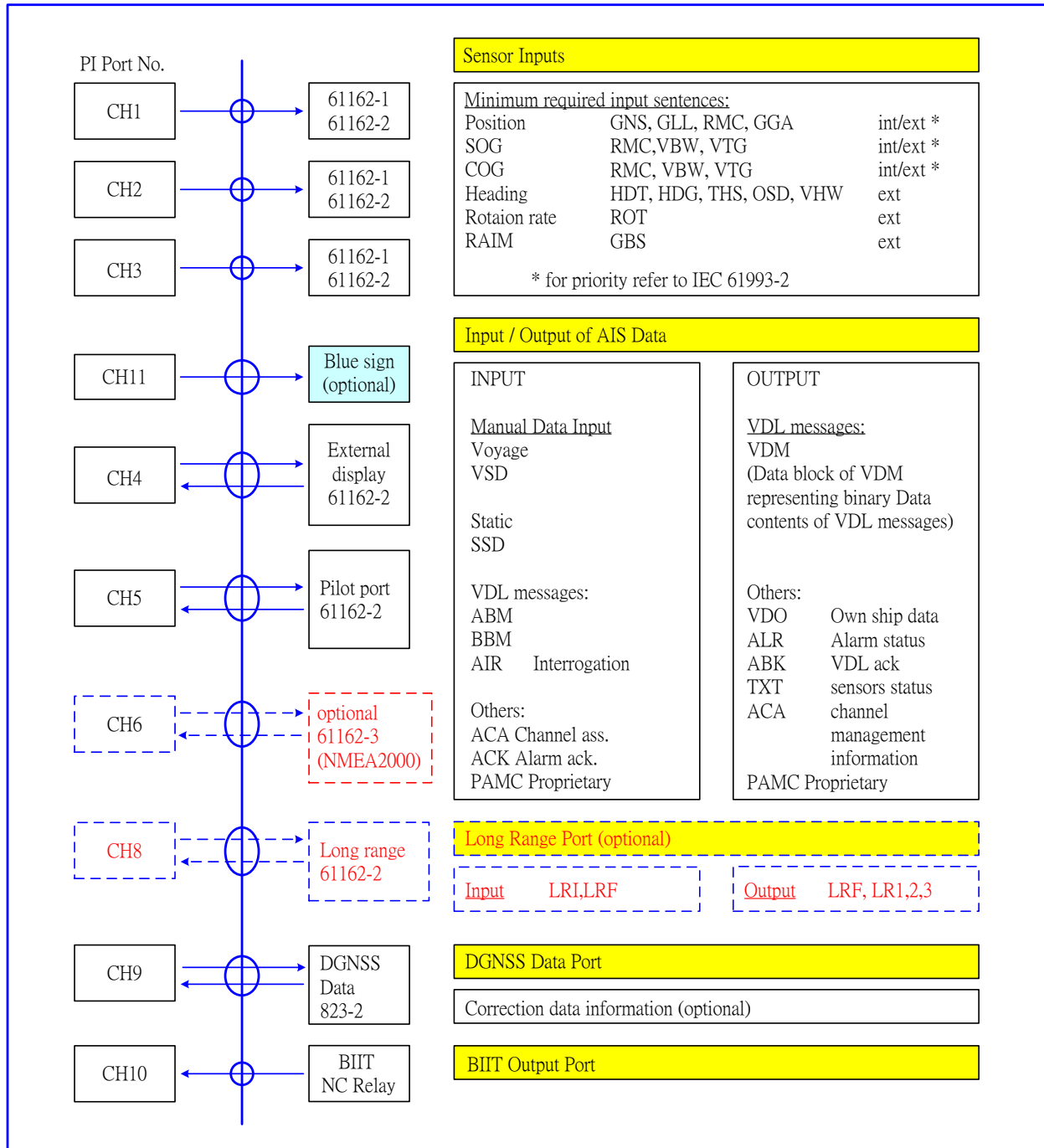

Figure A3 Presentation Interface of Smartfind M5

### A.3 Supported IEC 61162 Data Sentences

Data Port	Input Sentences	Output Sentences
Sensor 1 Sensor 2 Sensor 3	DTM, GNS, RMC, VBW, HDT, HDG, ROT, GBS, GLL, VTG, THS, GSA, GGA, OSD, VHW	N/A
DGPS	DTM, GNS, RMC, VBW, HDT, HDG, ROT, GBS, GLL, VTG, THS, GSA, GGA, OSD, VHW	N/A
External Display	ABM, ACA, ACK, AIR, BBM, SSD, VSD, AIQ, LRI, LRF, SPW, EPV	ABK, ACA, VDM, VDO, TXT, ALR, LRF, LR1, LR2, LR3, EPV
Pilot	ABM, ACA, ACK, AIR, BBM, SSD, VSD, AIQ, LRI, LRF, SPW, EPV	ABK, ACA, VDM, VDO, TXT, ALR, LRF, LR1, LR2, LR3, EPV
Long Range	LRI, LRF	LRF, LR1, LR2, LR3

### A.4 Transmission Interval

Sentence	Interval
VDO	Once a second
ALR (active)	Once every thirty seconds
ALR (inactive)	Once every sixty seconds

## A.5 Interpretation of Input Sentences

### A.5.1 ABM – AIS Addressed Binary and Safety Related Message

This sentence supports ITU-R M.1371 Messages 6, 12, 25, 26 and provides an external application with a means to exchange data via an AIS transponder.

!--ABM,x,x,x,xxxxxxxxx,x,xx,s—s,x*hh<CR><LF>			
Field No.	Format	Description	Remark
1	x	Total number of sentences needed to transfer the message	
2	x	Sentence number	
3	x	Sequential message identifier	
4	xxxxxxx x	The MMSI of the destination AIS unit for the ITU-R M.1371 message	
5	x	AIS channel for broadcast of the radio message	
6	xx	ITU-R M.1371 message ID	
7	s—s	Encapsulated data	
8	x	Number of fill-bits	

### A.5.2 ACA – AIS Channel Assignment Message

An AIS device can receive regional channel management information.

\$-- ACA,x,IIII.II,a,yyyyy.yy,a,IIII.II,a,yyyyy.yy,a,x,xxxx,x,xxxx,x,x,x,a,x,hmmss.s s*hh<CR><LF>			
Field No.	Format	Description	Remark
1	x	Sequence Number	
2	IIII.II,a	Region northeast corner latitude – N/S	
3	yyyyy.yy,a	Region northeast corner longitude – E/W	
4	IIII.II,a	Region southwest corner latitude – N/S	
5	yyyyy.yy,a	Region southwest corner longitude – E/W	
6	x	Transition zone size	
7	xxxx	Channel A	
8	x	Channel A bandwidth	
9	xxxx	Channel B	
10	x	Channel B bandwidth	
11	x	Tx/Rx mode control	
12	x	Power level control	
13	a	Information source	
14	x	In-use flag	
15	hmmss.ss	Time of “in use” change	

### A.5.3 ACK – Acknowledge Alarm

This sentence is used to acknowledge an alarm condition reported by a device.

\$--ACK,xxx*hh<CR><LF>			
Field No.	Format	Description	Remark
1	xxx	Unique alarm number (identifier) at alarm source	

### A.5.4 AIQ - Query Sentence

This sentence is used to inquire AIS sentence information.

\$--AIQ,c—c*hh<CR><LF>			
Field No.	Format	Description	Remark
1	c—c	Support query sentence of ACA, EPV, SSD, VSD, TXT.	

### A.5.5 AIR – AIS Interrogation Request

This sentence supports ITU-R M.1371 messages 15 and 10. It provides an external application with the means to initiate requests for specific ITU-R M.1371 messages from AIS unit.

\$--AIR,xxxxxxxxx,x.x,x,x.x,x,xxxxxxxxx,x.x,x*hh<CR><LF>			
Field No.	Format	Description	Remark
1	xxxxxxxxx x	MMSI of interrogated station 1	
2	x.x	ITU-R M.1371 message requested from station-1	
3	x	Message sub-section	ignored
4	x.x	Number of second message requested from station-1	
5	x	Message sub-section	ignored
6	xxxxxxxxx x	MMSI of interrogated station-2	
7	x.x	Number of messages requested from station-2	
8	x	Message sub-section	ignored

### A.5.6 BBM – AIS Broadcast Binary Message

This sentence supports generation of ITU-R M.1371 binary messages 8, 14, 25, and 26. This provides the application with a means to broadcast data, as defined by the application only.

!--BBM,x,x,x,x,x,x,s—s,x*hh<CR><LF>			
Field No.	Format	Description	Remark
1	x	Total number of sentences needed to transfer the message	
2	x	Sentence number	
3	x	Sequential message identifier	
4	x	AIS channel for broadcast of the radio message	
5	x.x	ITU-R M.1371 Message ID	
6	s—s	Encapsulated data	
7	x	Number of fill-bits	

### A.5.7 DTM – Datum Reference

Local geodetic datum and datum offsets from a reference datum.

\$--DTM,ccc,a,x.x,a,x.x,a, x.x,ccc*hh<CR><LF>			
Field No.	Format	Description	Remark
1	ccc	Local datum	
2	a	Local datum subdivision code	ignored
3	x.x, a	Lat offset, min, N/S	ignored
4	x.x, a	Lon offset, min, E/W	ignored
5	x.x	Altitude offset, m	ignored
6	ccc	Reference datum	

### A.5.8 EPV – Command or Report Equipment Property Value

\$--EPV,a,cc,c--c,x.x,c--c*hh<CR><LF>			
Field No.	Format	Description	Remark
1	a	Sentence status flag	
2	cc	Destination equipment type	
3	c--c	Unique identifier	
4	x.x	Property identifier	
5	c--c	Value of property to be set	



### A.5.9 GBS – GNSS Satellite Fault Detection

This sentence is used to support receiver autonomous integrity monitoring (RAIM).

<b>\$--GBS, hhmss.ss, x.x, x.x, x.x, xx, x.x, x.x, x.x *hh &lt;CR&gt;&lt;LF&gt;</b>			
<b>Field No.</b>	<b>Format</b>	<b>Description</b>	<b>Remark</b>
1	hhmss.ss	UTC time of the GGA or GNS fix associated with this sentence	
2	x.x	Expected error in latitude	
3	x.x	Expected error in longitude	
4	x.x	Expected error in altitude	ignored
5	xx	ID number of most likely failed satellite	ignored
6	x.x	Probability of missed detection for most likely failed satellite	ignored
7	x.x	Estimate of bias on most likely failed satellite	ignored
8	x.x	Standard deviation of bias estimate	ignored

### A.5.10 GGA – Global positioning system (GPS) fix data

Time, position and fix-related data for a GPS receiver.

<b>\$--GGA, hhmss.ss, llll.ll, a, yyyyy.yy, a, x, xx, x.x, x.x, M, x.x, M, x.x, xxxx*hh&lt;CR&gt;&lt;LF&gt;</b>			
<b>Field No.</b>	<b>Format</b>	<b>Description</b>	<b>Remark</b>
1	hhmss.ss	UTC of position	
2	llll.ll,a	Latitude N/S	
3	yyyyy.yy,a	Longitude E/W	
4	x	GPS quality indicator	ignored
5	xx	Number of satellites in use, 00-12, may be different from the number in view	ignored
6	x.x	Horizontal dilution of precision	ignored
7	x.x	Antenna altitude above/below mean sea level (geoid)	ignored
8	M	Units of antenna altitude, m	ignored
9	x.x	Geoidal separation	ignored
10	M	Units of geoidal separation, m	ignored
11	x.x	Age of differential GPS data	ignored
12	xxxx	Differential reference station ID, 0000-1023	ignored

### A.5.11 GLL – Geographic Position – Latitude/Longitude

Latitude and longitude of vessel position, time of position fix and status.

<b>\$--GLL, llll.ll, a, yyyyy.yy, a, hhmss.ss, A, a *hh&lt;CR&gt;&lt;LF&gt;</b>			
<b>Field No.</b>	<b>Format</b>	<b>Description</b>	<b>Remark</b>
1	llll.ll, a	Latitude, N/S	
2	yyyyy.yy, a	Longitude, E/W	
3	hhmss.ss	UTC of position	
4	A	Status, A=data valid V=data invalid	
5	a	Mode indicator	

### A.5.12 GNS – GNSS Fix Data

Fix data for single or combined satellite navigation systems (GNSS). This sentence provides fix data for GPS, GLONASS, possible future satellite systems and systems combining these.

<b>\$-- GNS, hhmmss.ss, llll.ll, a, yyyyy.yy, a, c--c,xx,x.x,x.x,x.x,x.x,x.x,a *hh&lt;CR&gt;&lt;LF&gt;</b>			
Field No.	Format	Description	Remark
1	hhmmss.ss	UTC of position	
2	llll.ll, a	Latitude, N/S	
3	yyyyy.yy, a	Longitude, E/W	
4	c--c	Mode indicator	
5	xx	Total number of satellites in use	ignored
6	x.x	HDOP	ignored
7	x.x	Antenna altitude, m, re:mean-sea-level (geoid)	ignored
8	x.x	Geoidal separation, m	ignored
9	x.x	Age of differential data	ignored
10	x.x	Differential reference station ID	ignored
11	a	Nacigational status indicator	

### A.5.13 GSA – GNSS DOP and Active Satellites

GNSS receiver operating mode, satellites used in the navigation solution reported by the GGA or GNS sentences, and DOP values. If only GPS, GLONASS, etc. are used for the reported position solution, the talker ID is GP, GL, etc. and the DOP values pertain to the individual system.

<b>\$--GSA, a, x, xx,xx,xx,xx,xx,xx,xx,xx,xx,xx,xx,x.x,x.x,x.x*hh&lt;CR&gt;&lt;LF&gt;</b>			
Field No.	Format	Description	Remark
1	a	Mode: M = manual, forced to operate in 2D or 3D mode A = automatic, allowed to automatically switch 2D/3D	
2	x	Mode: 1 = fix not available, 2 = 2D, 3 = 3D	
3	xx,xx,xx,xx,xx,xx,xx,xx,xx,xx,xx,xx	ID numbers of satellites used in solution	
4	x.x	PDOP	
5	x.x	HDOP	
6	x.x	VDOP	

#### A.5.14 HDG – Heading, Deviation and Variation

Heading (magnetic sensor reading), which if corrected for deviation will produce magnetic heading, which if offset by variation will provide true heading.

\$--HDG, x.x, x.x, a, x.x, a*hh<CR><LF>			
Field No.	Format	Description	Remark
1	x.x	Magnetic sensor heading, degrees	
2	x.x,a	Magnetic deviation, degrees E/W	
3	x.x,a	Magnetic variation, degrees E/W	

#### A.5.15 HDT – Heading True

Actual vessel heading in degrees true produced by any device or system producing true heading.

\$--HDT, x.x, T*hh<CR><LF>			
Field No.	Format	Description	Remark
1	x.x, T	Heading, degrees true	

#### A.5.16 LRF – AIS Long-Range Function

This sentence is used in both long-range interrogation requests and long-range interrogation replies. The LRF-sentence is the second sentence of the long-range interrogation request pair, LRI and LRF (see the LRI-sentence).

\$--LRF, x, xxxxxxxxx, c—c, c—c, c—c*hh<CR><LF>			
Field No.	Format	Description	Remark
1	x	Sequence number	
2	xxxxxxxxx	MMSI of requestor	
3	c—c	Name of requestor	
4	c—c	Function request	
5	c—c	Function reply status	

#### A.5.17 LRI – AIS Long-Range Interrogation

The long-range interrogation of the AIS unit is accomplished through the use of two sentences. The pair of interrogation sentence formatters, a LRI sentence followed by a LRF sentence, provides the information needed by a universal AIS unit to determine if it should construct and provide the reply sentences (LRF, LR1, LR2, and LR3).

\$-- LRI, x, a, xxxxxxxxx, xxxxxxxxx, llll.ll, a, yyyyy.yy, a, llll.ll, a, yyyyy.yy, a*hh<CR><LF>			
Field No.	Format	Description	Remark
1	x	Sequence number	
2	a	Control flag	
3	xxxxxxxxx	MMSI of requestor	
4	xxxxxxxxx	MMSI of destination	
5	llll.ll, a	Latitude – N/S	
6	yyyyy.yy, a	Longitude – E/W	
7	llll.ll, a	Latitude – N/S	
8	yyyyy.yy, a	Longitude – E/W	

### A.5.18 OSD – Own Ship Data

Heading, course, speed, set and drift summary. Useful for, but not limited to radar/ARPA applications. OSD gives the movement vector of the ship based on the sensors and parameters in use.

\$--OSD, x.x,A,x.x, a,x.x,a,x.x,x.x,a*hh<CR><LF>			
Field No.	Format	Description	Remark
1	x.x	Heading, degrees true	
2	A	Heading status: A = data valid, V = data invalid	
3	x.x	Vessel course, degrees true	Ignored
4	a	Course reference, B/M/W/R/P (see Note)	Ignored
5	x.x	Vessel speed	Ignored
6	a	Speed reference, B/M/W/R/P (see Note)	Ignored
7	x.x	Vessel set, degrees true	Ignored
8	x.x	Vessel drift (speed)	Ignored
9	a	Speed units, K = km/h; N = knots; S = statute miles/h	ignored

### A.5.19 RMC – Recommended Minimum Specific GNSS Data

Time, date, position, course and speed data provided by a GNSS navigation receiver.

\$--RMC, hhmmss.ss, A, llll.ll,a, yyyyyy.yy, a, x.x, x.x, xxxxxx, x.x,a, a, a*hh<CR><LF>			
Field No.	Format	Description	Remark
1	hhmmss.ss	UTC of position fix	
2	A	Status	
3	llll.ll,a	Latitude, N/S	
4	yyyyyy.yy, a	Longitude, E/W	
5	x.x	Speed over ground, knots	
6	x.x	Course over ground, degrees true	
7	xxxxxx	Date: dd/mm/yy	
8	x.x,a	Magnetic variation, degrees, E/W	
9	a	Mode indicator	
10	a	Navigational status	

### A.5.20 ROT – Rate of Turn

Rate of turn and direction of turn.

\$--ROT, x.x, A*hh<CR><LF>			
Field No.	Format	Description	Remark
1	x.x	Rate of turn, °/min	
2	A	Status: A = data valid, V = data invalid	

### A.5.21 SPW - Security Password Sentence

This sentence can be used for authentication. For this purpose the sentence has to be applied before the protected sentence (for example EPV, SSD).

\$--SPW,ccc,c--c,x,c--c*hh<CR><LF>			
Field No.	Format	Description	Remark
1	ccc	Password protected sentence	
2	c--c	Unique Identifier	
3	x	Password level	
4	c--c	Password	

### A.5.22 SSD – AIS Ship Static Data

This sentence is used to enter static parameters into a shipboard AIS unit. The parameters in this sentence support a number of the ITU-R M.1371 Messages.

\$--SSD,c—c,c—c,xxx,xxx,xx,xx,c,aa*hh<CR><LF>			
Field No.	Format	Description	Remark
1	c—c	Ship's call sign	
2	c—c	Ship's name	
3	xxx	Pos. ref., point dist. "A,"	
4	xxx	Pos. ref.,point dist. "B,"	
5	xx	Pos. ref., point dist. "C,"	
6	xx	Pos. ref.,point dist. "D,"	
7	c	DTE indicator flag	
8	aa	Source identifier	

### A.5.23 THS – True Heading and Status

Actual vessel heading in degrees true produced by any device or system producing true heading. This sentence includes a "mode indicator" field providing critical safety related information about the heading data, and replaces the deprecated HDT sentence.

\$--THS,x.x,a*hh<CR><LF>			
Field No.	Format	Description	Remark
1	x.x	Heading, degrees true	
2	a	Mode indicator	

### A.5.24 VBW – Dual Ground/Water Speed

Water-referenced and ground-referenced speed data.

\$--VBW, x.x, x.x, A, x.x, x.x, A, x.x, A, x.x, A*hh<CR><LF>			
Field No.	Forma t	Description	Remark
1	x.x	Longitudinal water speed, knots	ignored
2	x.x	Transverse water speed , knots	ignored
3	A	Status : water speed, A = data valid, V = data invalid	ignored
4	x.x	Longitudinal ground speed , knots	
5	x.x	Transverse ground speed , knots	

6	A	Status , ground speed, A = data valid, V = data invalid	
7	x.x	Stern transverse water speed , knots	ignored
8	A	Status : stern water speed,A = data valid, V = data invalid	ignored
9	x.x	Stern transverse ground speed ,knots	ignored
10	A	Status : stern ground speed,A = data valid, V = data invalid	ignored

#### A.5.25 VHW – Water Speed and Heading

The compass heading to which the vessel points and the speed of the vessel relative to the water.

\$--VHW, x.x, T, x.x, M, x.x, N, x.x, K*hh<CR><LF>			
Field No.	Format	Description	Remark
1	x.x, T	Heading, degrees true	
2	x.x, M	Heading, degrees magnetic	Ignored
3	x.x, N	Speed, knots	Ignored
4	x.x, K	Speed, km/h	Ignored

#### A.5.26 VSD – AIS Voyage Static Data

This sentence is used to enter information about a ship's transit that remains relatively static during the voyage.

\$--VSD,x.x,x.x,x.x,c—c,hmmss.ss,xx,xx,x.x,x.x*hh<CR><LF>			
Field No.	Format	Description	Remark
1	x.x	Type of ship and cargo category	
2	x.x	Maximum present static draught	
3	x.x	Persons on-board	
4	c—c	Destination	
5	hmmss.ss	Estimated UTC of arrival at destination	
6	xx	Estimated day of arrival at destination	
7	xx	Estimated month of arrival at destination	
8	x.x	Navigational status	
9	x.x	Regional application flags	

#### A.5.27 VTG – Course Over Ground and Ground Speed

The actual course and speed relative to the ground.

\$--VTG, x.x, T, x.x, M, x.x, N, x.x, K,a*hh<CR><LF>			
Field No.	Format	Description	Remark
1	x.x, T	Course over ground, degrees true	
2	x.x, M	Course over ground, degrees magnetic	ignored
3	x.x, N	Speed over ground, knots	
4	x.x, K	Speed over ground, km/h	ignored
5	a	Mode indicator	

### A.5.28 PAMC, DBG – Proprietary Sentences, Debug

The proprietary sentences are additional sentences only applicable to this product. Its main usage is for enabling testing mode and parameter settings.

This sentence is used for configuration. It commands unit with given parameters.

\$PAMC,C,c-c,x,x,x,x,x,x,x,x*hh<CR><LF>			
Field No.	Format	Description	remark
1	C	Command : "C"	
2	c-c	Function type. For example, DBG.	
3	x	Parameter Id 1 , 0-998	
4	x	Parameter value 1 , 0- 1000000000	
5	x	Parameter Id 2 , 0-998	
6	x	Parameter value 2, 0- 1000000000	
7	x	Parameter Id 3 , 0-998	
8	x	Parameter value 3, 0- 1000000000	
7	x	Parameter Id 4 , 0-998	
8	x	Parameter value 4, 0- 1000000000	

This sentence is used for retrieving responses.

\$PAMC,R,c-c,x,x,x,x,x,x,x,x*hh<CR><LF>			
Field No.	Format	Description	Remark
1	R	Response : "R"	
2	c-c	Function type. For example, DBG.	
3	x	Parameter Id 1 , 0-998	
4	x	Parameter value 1 , 0- 1000000000	
5	x	Parameter Id 2 , 0-998	
6	x	Parameter value 2, 0- 1000000000	
7	x	Parameter Id 3 , 0-998	
8	x	Parameter value 3, 0- 1000000000	
7	x	Parameter Id 4 , 0-998	
8	x	Parameter value 4, 0- 1000000000	

### A.5.29 PAMC, DSC – Proprietary Sentences, Digital selective calling

When AIS transponder receives DCS messages, this sentence is used to output DSC pattern.

\$PAMC,R,DSC,c-c*hh<CR><LF>			
Field No.	Format	Description	Remark
1	c-c	DSC pattern	

## A.6 Interpretation of Output Sentences

### A.6.1 ABK – AIS Addressed and Binary Broadcast Acknowledgement

The ABK-sentence is generated when a transaction, initiated by reception of an ABM, AIR, or BBM sentence, is completed or terminated.

\$--ABK,xxxxxxxx,x,x.x,x,x*hh<CR><LF>			
Field No.	Format	Description	Remark
1	xxxxxxxx x	MMSI of the addressed AIS unit	
2	x	AIS channel of reception	
3	x.x	ITU-R M.1371 Message ID	
4	x	Message sequence number	
5	x	Type of acknowledgement	

### A.6.2 ACA – AIS Channel Assignment Message

An AIS device can receive regional channel management information

\$- ACA,x,IIII.II,a,yyyyy.yy,a,IIII.II,a,yyyyy.yy,a,x,xxxx,x,xxxx,x,x,x,a,x,hhmmss.ss*hh<CR><LF>			
Field No.	Format	Description	Remark
1	x	Sequence Number	
2	IIII.II,a	Region northeast corner latitude – N/S	
3	yyyyy.yy,a	Region northeast corner longitude – E/W	
4	IIII.II,a	Region southwest corner latitude – N/S	
5	yyyyy.yy,a	Region southwest corner longitude – E/W	
6	x	Transition zone size	
7	xxxx	Channel A	
8	x	Channel A bandwidth	
9	xxxx	Channel B	
10	x	Channel B bandwidth	
11	x	Tx/Rx mode control	
12	x	Power level control	
13	a	Information source	
14	x	In-use flag	
15	hhmmss.ss	Time of “in use” change	



### A.6.3 ALR – Set Alarm State

Local alarm condition and status. This sentence is used to report an alarm condition on a device and its current state of acknowledgement.

\$--ALR,hhmmss.ss,xxx,A, A,c--c*hh<CR><LF>			
Field No.	Format	Description	Remark
1	hhmmss.ss	Time of alarm condition change, UTC	
2	xxx	Unique alarm number (identifier) at alarm source	
3	A	Alarm condition, A = threshold exceeded, V = not exceeded	
4	A	Alarm's acknowledge state, A = acknowledged, V = unacknowledged	
5	c--c	Alarm's description text	

### A.6.4 EPV – Command or Report Equipment Property Value

\$--EPV,a,cc,c--c,x.x,c--c*hh<CR><LF>			
Field No.	Format	Description	Remark
1	a	Sentence status flag	
2	cc	Destination equipment type	
3	c--c	Unique identifier	
4	x.x	Property identifier	
5	c--c	Value of property to be set	

### A.6.5 LR1 – AIS Long-Range Reply Sentence 1

The LR1 sentence identifies the destination for the reply and contains the information items requested by the "A" function identification character (see the LRF sentence).

\$--LR1,x,xxxxxxxx,xxxxxxxx,c—c,c—c,xxxxxxxx*hh<CR><LF>			
Field No.	Format	Description	Remark
1	x	Sequence number	
2	xxxxxxxx	MMSI of responder	
3	xxxxxxxx	MMSI of requestor	
4	c—c	Ship's name, 1 to 20 characters	
5	c—c	Call sign, 1 to 7 characters	
6	xxxxxxxx	IMO number, 9-digit number	

### A.6.6 LR2 – AIS Long-Range Reply Sentence 2

The LR2-sentence contains the information items requested by the “B, C, E and F” function identification characters,(see the LRF sentence)

\$-- LR2,x,xxxxxxxx,xxxxxxxx,hhmmss.ss,IIII.II,a,yyyy.yy,a,x.x,T,x.x,N*hh<CR> <LF>			
Field No.	Format	Description	Remark
1	x	Sequence number	
2	xxxxxxxx	MMSI of responder	
3	xxxxxxxx	Date: ddmmyyyy, 8 digits	
4	hhmmss.ss	UTC time of position	
5	IIII.II,a	Latitude – N/S	
6	yyyy.yy,a	Longitude, E/W	
7	x.x,T	Course over ground, degrees, true	
8	x.x,N	Speed over ground, knots	

### A.6.7 LR3 – AIS Long-Range Reply Sentence 3

The LR3 sentence contains the information items requested by the “I, O, P, U and W” function identification character (see the LRF sentence).

\$--LR3,x,xxxxxxxx,c— c,xxxxxx,hhmmss.ss,x.x,x.x,x.x,x.x,x.x*x*hh<CR><LF>			
Field No.	Format	Description	Remark
1	x	Sequence number	
2	xxxxxxxx	MMSI of responder	
3	c—c	Voyage destination, 1 to 20 chars	
4	xxxxxx	ETA date: ddmmyy	
5	hhmmss.ss	ETA time	
6	x.x	Draught	
7	x.x	Ship/cargo	
8	x.x	Ship length	
9	x.x	Ship breadth	
10	x.x	Ship type	
11	x.x	Persons, 0 to 8191	

### A.6.8 LRF – AIS Long-Range Function

This sentence is used in both long-range interrogation requests and long-range interrogation replies. The LRF-sentence is the second sentence of the long-range interrogation request pair; LRI and LRF (see the LRI-sentence).

\$--LRF,x,xxxxxxxx,c—c,c—c,c—c*hh<CR><LF>			
Field No.	Format	Description	Remark
1	x	Sequence number	
2	xxxxxxxx	MMSI of requestor	
3	c—c	Name of requestor	
4	c—c	Function request	
5	c—c	Function reply status	

### A.6.9 TXT – Text Transmission

For the transmission of short text messages. Longer text messages may be transmitted by using multiple sentences.

\$--TXT,xx,xx,xx,c--c*hh<CR><LF>			
Field No.	Format	Description	Remark
1	xx	Total number of sentences	
2	xx	Sentence number	
3	xx	Text identifier	
4	c--c	Text message	

### A.6.10 VDM – AIS VHF Data-Link Message

This sentence is used to transfer the entire contents of a received AIS message packet, as defined in ITU-R M.1371 and as received on the VHF Data Link (VDL), using the “six-bit” field type.

!--VDM,x,x,x,a,s—s,x*hh<CR><LF>			
Field No.	Format	Description	Remark
1	x	Total number of sentences needed to transfer the message	
2	x	Sentence number	
3	x	Sequential message identifier	
4	a	AIS channel	
5	s—s	Encapsulated ITU-R M.1371 radio message	
6	x	Number of fill-bits	

### A.6.11 VDO – AIS VHF Data-Link Own-Vessel Report

This sentence is used to transfer the entire contents of an AIS unit’s broadcast message packet, as defined in ITU-R M.1371 and as sent out by the AIS unit over the VHF data link (VDL) using the “six-bit” field type.

!--VDO,x,x,x,a,s—s,x*hh<CR><LF>			
Field No.	Format	Description	Remark
1	x	Total number of sentences needed to transfer the message	
2	x	Sentence number	
3	x	Sequential message identifier	
4	a	AIS channel	
5	s—s	Encapsulated ITU-R M.1371 radio message	
6	x	Number of fill-bits	

# APPENDIX (B)

## B.1 Monitoring of System Functions and Integrity

In case a failure is detected in one or more of the following functions or data, an alarm will be triggered and displayed on the menu-tree under Alarm List, and the system (transponder) will react as described in the following table.

Alarm's description text	Alarm ID	Reaction of the system (transponder)
AIS: Tx malfunction	001	Stop transmission
AIS: Antenna VSWR exceeds limit	002	Continue operation
AIS: Rx channel 1 malfunction	003	Stop transmission on affected channel
AIS: Rx channel 2 malfunction	004	Stop transmission on affected channel
AIS: Rx channel 70 malfunction	005	Continue operation
AIS: general failure	006	Stop transmission
AIS: UTC sync invalid	007	Continue operation using indirect or semaphore synchronisation
AIS: MKD connection lost	008	Continue operation
AIS: internal / external GNSS position mismatch	009	Continue operation
AIS: NavStatus incorrect	010	Continue operation
Heading sensor offset	011	Continue operation
AIS: active AIS SART	014	Continue operation
AIS: external EPFS lost	025	Continue operation
AIS: no sensor position in use	026	Continue operation
AIS: no valid SOG information	029	Continue operation using default data
AIS: no valid COG information	030	Continue operation using default data
AIS: Heading lost/invalid	032	Continue operation using default data
AIS: no valid ROT information	035	Continue operation using default data

## B.2 Antenna VSWR Exceeds Limit

There is a built-in RF output power detector, which is used to monitor the VSWR of VHF antenna port. If the antenna VSWR exceeds limit, an alarm will be reported while the unit operates continuously. The system will output an ALR 002 at related PI port.

## B.3 Detection of Tx Malfunction

A built-in lock detector (high active) is used to monitor the local oscillator (PLL circuit) of the transmitter. If the operation of PLL circuit becomes abnormal, a logic low (TX malfunction) will be sent from the lock detector to notify the system. At the same time, system will also output an ALR 001 at the related PI port.

## B.4 Detection of Rx Malfunction

The Smartfind M5 also has 3 built-in lock detectors (high active) to monitor each local oscillator (PLL circuit) of receiver channel 1, channel 2, and channel 70 respectively. If the operation of PLL circuit becomes abnormal, a logic low level will be sent from the lock detector to notify the system. At the same time, the system will output ALR 003 or ALR 004 or ALR 005 at the related PI port to indicate the CH1 or CH2 or CH70 RX malfunctions respectively.

# APPENDIX (C)

## Installation and Maintenance Record

The following installation record should be completed and retained on board the vessel for maintenance records.

Vessel Information			
Vessel Name		Flag State	
IMO Number		MMSI Number	
Owner/Company		Radio call sign	
Type of vessel		Gross tonnage	
Length		Beam	
	m		m

AIS Class A Transponder Information			
Transponder S/N		Pilot Plug S/N	
Junction Box S/N		GPS Ant. S/N	
Password			
Power supply	Voltage:	V	Maximum output current: A
Note			

GPS/GNSS Antenna Location			
A= Distance to Bow	m	C= Dist. To Port-Side	m
B= Distance to Stern	m	D= Dist. To Starboard	m

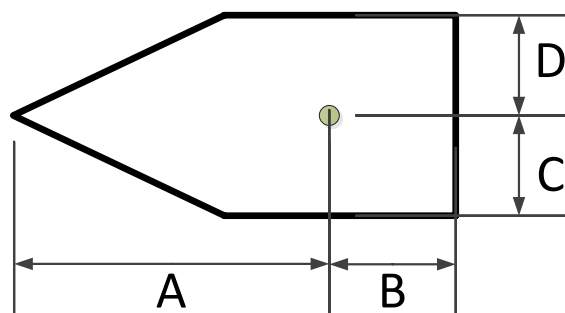

<b>Connected Sensors and Devices</b>		
<b>Connected Port</b>	<b>Equipment</b>	<b>Model Number</b>
<b>Sensor 1</b>		
<b>Sensor 2</b>		
<b>Sensor 3</b>		
<b>Ext Display Port</b>		
<b>Pilot Port</b>		
<b>Long Range Port</b>		
<b>DGNSS Data Port</b>		
<b>Other Device</b>		

<b>Installer Information</b>		
<b>Company Name</b>		
<b>Technician's Name</b>		
<b>Telephone/Mobile No.</b>		
<b>Address</b>		
<b>Place</b>	<b>Date</b>	<b>Installer's Signature</b>

## Software Revisions

The transponder is delivered with software version according to the following table which is to be filled in and maintained either by manufacturer, distributor, dealer, or Installation Company. When software update is done, the new software (firmware) version can be identified through MKD at MENU/DIAGNOSTICS/VERSION (please refer to section 4.12 in the manual). Each new software upgrade requires information recorded to reflect the change made.

Software Maintenance Record			
Software Version	By	Date	Change

## APPENDIX (D)

---

### **USCG AIS Inspection Checklist & Report**

For USA vessel owners, please visit the USCG website to download the voluntary checklist to assist the surveyor or owner in ensuring the ship's Automatic Identification System (AIS) in operation is properly operating as defined in 33 CFR §164, 47 CFR §80, and, Safety of Life at Sea Convention (SOLAS) Chapter V Regulation 18.9.

USCG AIS Checklist is posted here:

[https://www.navcen.uscg.gov/pdf/AIS/USCG\\_AIS\\_Inspection\\_Checklist19\\_10\\_01.pdf](https://www.navcen.uscg.gov/pdf/AIS/USCG_AIS_Inspection_Checklist19_10_01.pdf)

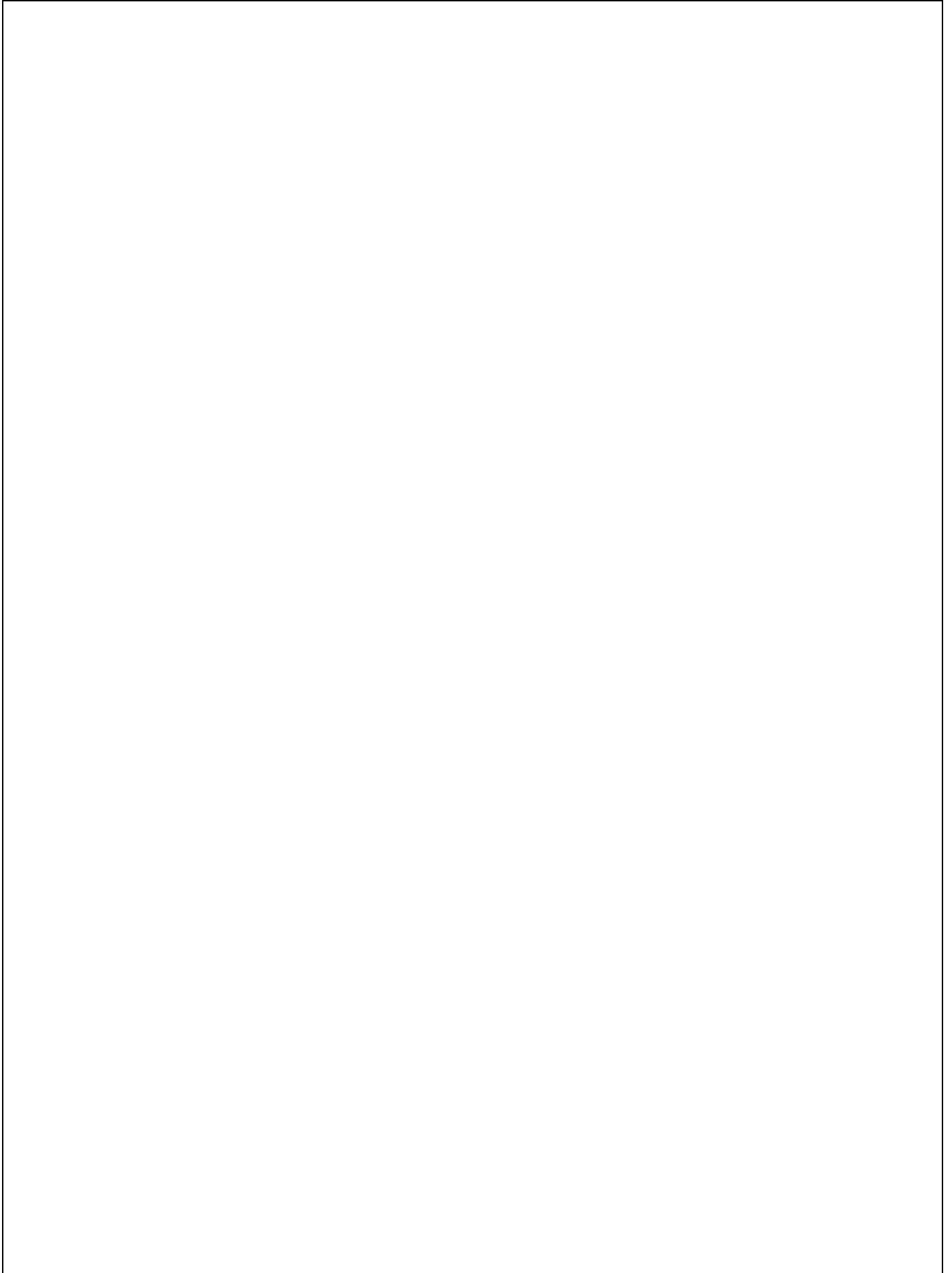

**Note:**

A large, empty rectangular box with a thin black border, occupying most of the page. It is intended for the user to write their notes.



**Netwave Systems B.V.**

Blauw-roodlaan 100,  
2718 SJ Zoetermeer,  
Netherlands

Phone: +31 (0) 8811 81500

Email: [customer.service@seasofsolutions.com](mailto:customer.service@seasofsolutions.com)  
Website: [www.seasofsolutions.com/](http://www.seasofsolutions.com/)

21-135-001 Issue 16

A Seas Of Solutions Business